

PRESSURISATION & WATER QUALITY

Air & Dirt Handbook

Acknowledgments

This handbook would not exist were it not for the meticulous hard work of two colleagues: Karoly Vinkler, always in our hearts, who began with the basics of the old "Luft Handbuch" and integrated the entire dirt separation chapter, and Norbert Ramser, who inherited his work, which he revised and embellished.

Contents

Air, gases and dirt in HVAC Systems.....	5
Gases in the Water.....	6
Entry of Air and Gases.....	8
Henry diagram	10
Gas Content when Filling, Commissioning and Operating the System	12
Dirt and Mud in the Water.....	14
Consequences Problems Damage	17
Water Quality According to VDI 2035.....	20
Venting and Separating Free Gas Bubbles	22
Principles of Separation for Dissolved Gases.....	27
Atmospheric Degassing.....	29
Vacuum Degassing	30
Installation of Air Separators.....	34
Mounting of Vacuum Degassers.....	38
Dirt Separation	40
Installation in Practice	52
IMI Pneumatex solutions	62

Air, Gases and Dirt in HVAC Systems

Managing the water quality inside your HVAC system by removing air and dirt is an effective way to extend the lifetime of critical system elements while optimising system performance. This begins with the initial filling of the system and the make-up water used.

The benefits of good water-quality management include:

- reduced energy consumption
- prolonged system service life
- quiet operation
- no downtime

The presence of air in the water must be minimised, not only to reduce corrosion problems, but also because its presence reduces heat transfer from terminal units. The creation of air pockets can even prevent circulation locally. More importantly, there is considerably more risk both of cavitation and of noise in the pipes, control valves and so on.

Free gases and dissolved gases have a direct and indirect influence respectively on flow measurements.

A gas's solubility limit in water decreases as temperature increases and pressure decreases. Control valves and balancing valves located in the upper parts of the building are therefore the most exposed as they are subject to a low static pressure. The increased water velocity near the valve seats causes a further pressure drop, enabling the reabsorption of nitrogen and other dissolved gases. In this case, the actual flows measured are incorrect. Particularly in the case of small valves, the flow measured is greater than the actual flow rate.

Gases in the Water

Gases can cause various problems in heating and cooling systems



- Corrosion
- Deposits from corroded products
- Noise
- Circulation problems
- Reduction in heating performance

What do we mean by gases and where do they come from?

Gases are already in the water before it is used to fill the installation. Air enters the water from the atmosphere in the water reservoirs (such as lakes and rivers) prior to the water being included in the supply water network.

It is both helpful and important to know what **air** is composed of.

The main components of dry air:

78.08%

● **Nitrogen**

0.93%

Argon

20.95%

● **Oxygen**

0.04%

others: noble gases, carbon dioxide, methane, hydrogen, etc.

When we say 'air', we essentially mean nitrogen and oxygen, which have a decisive influence on the gas composition in the heat transfer fluid.

On the basis of several measurements in practice, the quantities of nitrogen and oxygen are close to the saturation limit at the atmospheric pressure in the filling water. One litre of water contains 14.8 ml (18.5 mg) of nitrogen and 7.8 ml (11.3 mg) of oxygen.

Air can also enter the system by way of diffusion, e.g. through commonly used plastic or rubber materials, or due to an unwanted "vacuum" (negative pressure) which may occur in the installation.

Other gases, such as carbon dioxide (CO₂), methane (CH₄) and Hydrogen (H₂), are the result of electro-chemical corrosion and biochemical processes of the medium inside the installation.

● **Nitrogen** is a stable gas that accumulates as an inert gas after the system has been filled and during operation. This is often caused by residual air trapped when the system is being filled that dissolves as the pressure increases. Quantities up to 40 ml/l have been measured in systems. This is three times higher than the natural concentration and exceeds the solubility in water during the heating-up phase. The consequence

is free nitrogen bubbles. It has been proven that these are one of the main causes of classic "air problems" [1].

● **Oxygen** is actively involved in the electro-chemical corrosion. In hydronic systems with a high proportion of steel and iron materials, corrosion reduces the oxygen content of the water from 7.8 ml/l (11.2 mg/l) to 0.07 ml/l (0.1 mg/l) within a few hours of

filling the system. This corresponds to the limit value for corrosion of 0.1 mg/l [2]. This is a clear sign of the danger of oxygen and how important it is that closed hydronic systems avoid the ingress of air with the heat transfer fluid.

The air problems are illustrated in the following saturation diagram. While **nitrogen** causes bubble (free gas) problems, dissolved **oxygen** may lead to corrosion problems.

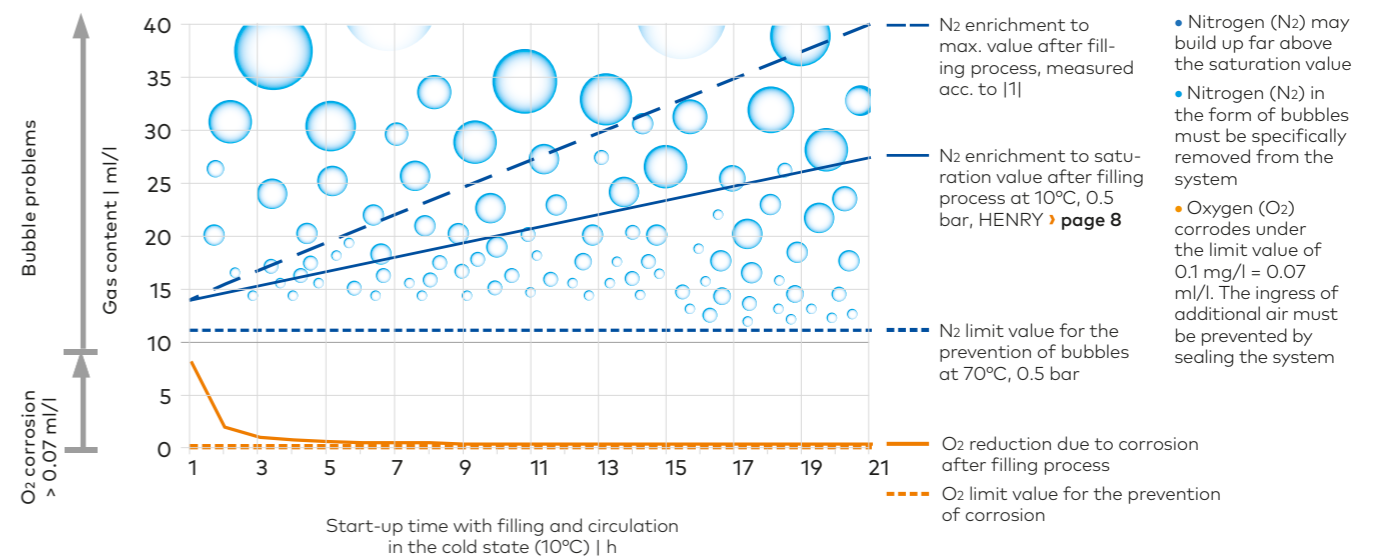

Malfunctions that cause disturbing flow noise or a lack of heating capacity on the highest radiators, which can be managed at short notice by venting the system but which recur again and again, can be observed only in closed hot-water heating systems. These are the result of gases formed by corrosion and microbiological processes in the system.

The gases produced here, methane (CH₄) and hydrogen (H₂), can accumulate until oversaturation and, apart from air, they are the most common causes of problems and are increasingly being detected.

Methane (CH₄) indicates the presence of bacteria (e.g. biofilm).

Hydrogen (H₂) can form in plants with steel materials according to the so-called "Schikorr" reaction: $Fe^{2+} + 6 OH > Fe_3O_4 + 2 H_2O + H_2$ In order for this reaction to occur, the speed of which increases with increasing temperature, there must be sufficient oxygen for iron to be brought to the reaction but not so much as to encourage the

formation of magnetite without hydrogen development. In addition, corrosion processes like such as. $2 Al + 2 H_2 > Al_2O_3 + 2 H_2$ (aluminium oxide formation) or $Al + 2 H_2O + NaOH > NA[Al(OH)_4] + 3/2 H_2$ (aluminate formation) can release hydrogen. The range of the pH value, the degree of softening or demineralisation, and the alloy stability of the aluminium components that are present play a decisive role in ensuring that these processes do not take place.

Carbon dioxide (CO₂) gets into the water as it seeps through the humus layer. Here it picks up the carbon dioxide produced by the decomposition of organic substances. The quantity of dissolved carbon dioxide is directly related to the pH value, which decreases when the CO₂ concentration increases and increases when the CO₂ concentration decreases.

CO₂ reacts with water to form a reaction product, H₂CO₃ (carbonic acid), and reduces the pH value of the water.

Entry of Air and Gases

The entry, generation and accumulation of gases must be kept to a minimum, and gases that interfere with operation must be removed. This strategy must be taken into account throughout the service life of the plant, from the design stage and commissioning up to decommissioning

A good example of the various ways that gases can appear in the heating water is inadequate venting processes when the system is first being filled.

As a system is being filled, air, which is lighter, is displaced by water and rises to the top. If the venting is not performed properly, the air accumulates at the higher points. Under pressure, the air can dissolve in the water again. This results in oversaturation because, later, during the heating-up process, the water's solubility decreases and free bubbles are generated that circulate with the flow. The dissolved air in the filling water remains "trapped", forming air cushions, for example.

Causes of air ingress and gas generation

- Air pockets due to inadequate or insufficient venting during initial filling and start-up
- Air pockets due to inadequate filling and venting after conversion, extension, repair and maintenance measures
- Water vapour diffusion through non-diffusion-tight components (e.g. seals, plastic pipes, elastomer connecting hoses) as well as continuous micro-water leakage from aged, brittle or worn and thus leaky sealing materials (flat seals, elastomer O-rings, gland seals of valves) that requires make-up water with corresponding N₂ and O₂ input
- Oxygen diffusion through non-diffusion-tight components (e.g. in panel heating systems with unsuitable plastic pipes or in mixed installations with a great number of elastomer connecting hoses). There is also a high risk of oxygen diffusion for compressor and pump pressure maintenance where butyl is not used for the membranes of the expansion vessels. Since the diffusion rate increases exponentially with rising temperature (doubling for roughly every 10K), pump pressure maintenance systems that use their expansion vessel for atmospheric degassing of the hot return water are to be considered particularly critical
- Air entrainment due to permanent or temporary negative pressure situations at any point in the installation. In a properly designed and installed pressurisation system made from high-quality components and materials and properly operated, negative pressure situations should not occur in the system at any point or time. In most cases, negative pressure situations indicate defective pressurisation. This may be caused by one of the following:
 - Gas preset pressure p₀ that is too low or too high in static expansion vessels

- Excessive loss of inlet pressure due to diffusion in static expansion vessels between two maintenance intervals (EPDM diffusion rate is extremely high, NBR is very high and butyl is almost diffusion-tight)
- Minimum operating pressure (p₀) set too low or incorrectly set initial pressure (p_a) in compressor and pump pressure maintenance systems
- Expansion vessel dimensioned too small
- Insufficiently dimensioned pressurisation pumps and compressors
- Insufficient water reserve in the expansion tank.
- Safety valves that open due to correctly designed set pressure or inadequate pressurisation that requires make-up water, with consequent N₂ and O₂ entry
- N₂ and O₂ entry through make-up water: oxygen leads to corrosive processes, and nitrogen is inert, accumulates in the system and can lead to free gas bubbles
- Formation of gases during corrosion and microbiological processes in the system, resulting in methane (CH₄) and hydrogen (H₂) potentially accumulating to the point of oversaturation. Along with N₂, CH₄ and H₂ are the most frequent cause of problems

Occurrence of gases in the water

Gases may occur in the water as free bubbles or in a molecularly dissolved form. HENRY's law describes the solubility. Gas oversaturation is located above the Henry curves (see pages 8-9). Here, dissolved gases come out of the solution as bubbles. In the case of gas undersaturation, all gases are dissolved.

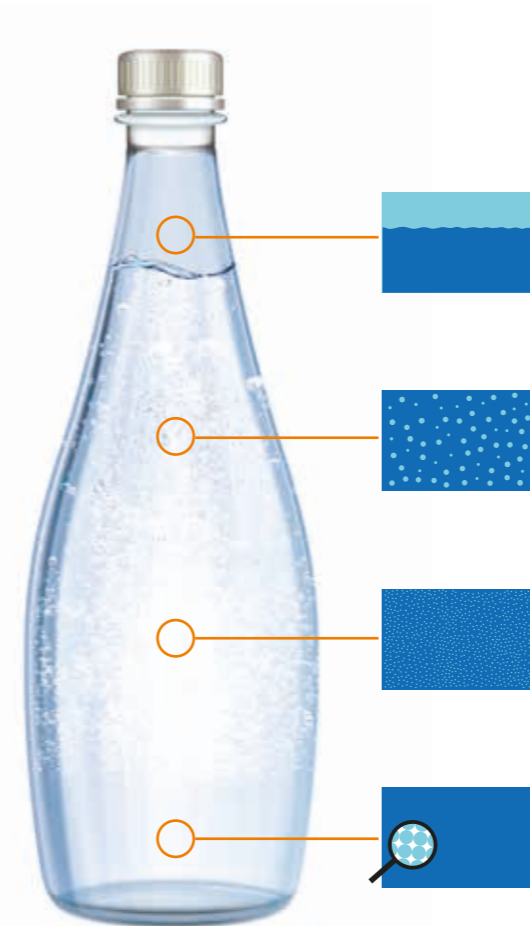

- **Accumulation of air in stagnant water at high points.** As a system is being filled, water displaces the air, which is lighter and rises to the top. If the venting is not performed properly, the air will accumulate at the higher points. Under pressure the air can – at least partially – dissolve in the water again. This results in oversaturation because during the subsequent heating-up process the water's solubility decreases and bubbles are generated that circulate with the flow.
- **Gas bubbles in flowing water.** Gas bubbles are carried along in the flow. In most cases, the flow in pipes is greater than the buoyancy of the bubbles. Therefore, separation is possible only with specific devices that can trap these bubbles.
- **Microbubbles are extremely small and occur in large numbers.** They can hardly be seen with the naked eye. The water appears to be milky white. They are carried along by the flow in such that they can be captured only by special separation devices. Larger bubbles "grow" if solid particles are present. The tendency to stick to surfaces makes the separation process more difficult and increases the risk of damage.
- **Dissolved gases are invisible.** The gas molecules are bonded to the water molecules such that they can be removed only by means of a pressure reduction or temperature increase. Due to the pressure and temperature differences in a system, dissolved gases can desorb into bubbles.

Henry Diagram

Henry's Law shows how much gas is dissolved in the water at different temperatures and pressures. Higher temperatures and lower pressures correspond with lower gas solubility.

Solubility of nitrogen in water according to Henry's Law

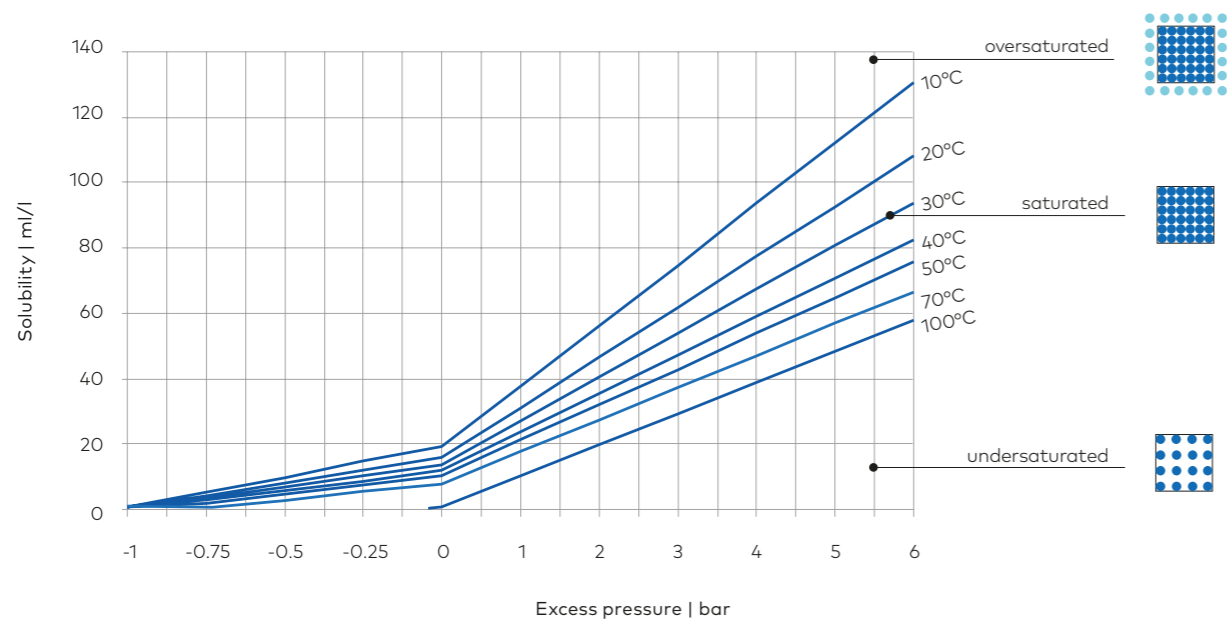

There is a specific Henry diagram for each gas.

This is the diagram for 100% nitrogen above the water, partial pressure $N_2 = 1$ bar abs.

This is the condition usually found in closed water circuits, as oxygen corrodes almost completely and can no longer be present in gaseous form.

The solubility for the atmospheric saturation is 78% of the diagram values. This corresponds to the gas share of nitrogen in the air, partial pressure $N_2 = 0.78$ bar abs.

Example 1

Let's consider a water-based hydronic system with an N_2 content of 60 ml/l at a local pressure of 3 bar and a temperature of 40°C. The maximum solubility of N_2 here is ~45 ml/l, where N_2 remains in a dissolved and invisible form – undersaturated. The remaining ~15 ml/l N_2 is in a free, visible form – oversaturated.

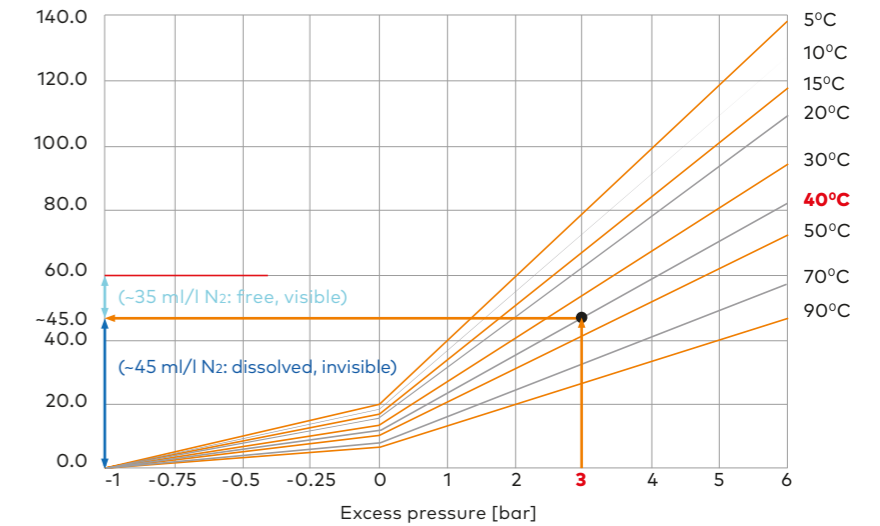

Example 2

If, at a constant pressure of 3 bar, the medium temperature rises from 40°C to 70°C and ~30 ml/l N_2 remains in a dissolved state and ~15 ml/l N_2 desorbs into the gaseous state, so that eventually ~30 ml/l N_2 will be present as free and visible gas bubbles. Microbubble separators can separate this amount of gas from the water and remove it from the system.

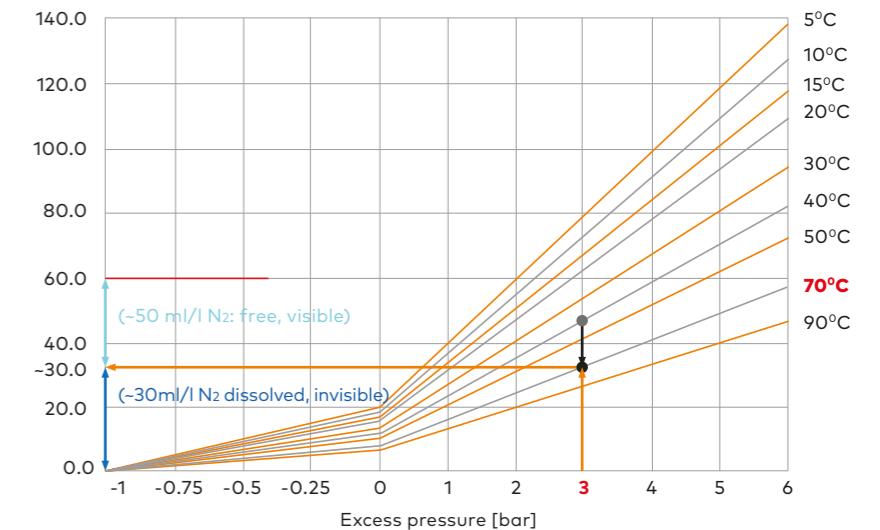

Example 3

If system pressure decreases to 0 bar, then the solubility of N_2 will decrease according to the saturation lines at given temperatures. At 0 bar system pressure and 40°C, only ~10 ml/l of N_2 will be in dissolved, invisible form. The remaining ~70 ml/l of gas can be dispatched by a microbubble separator.

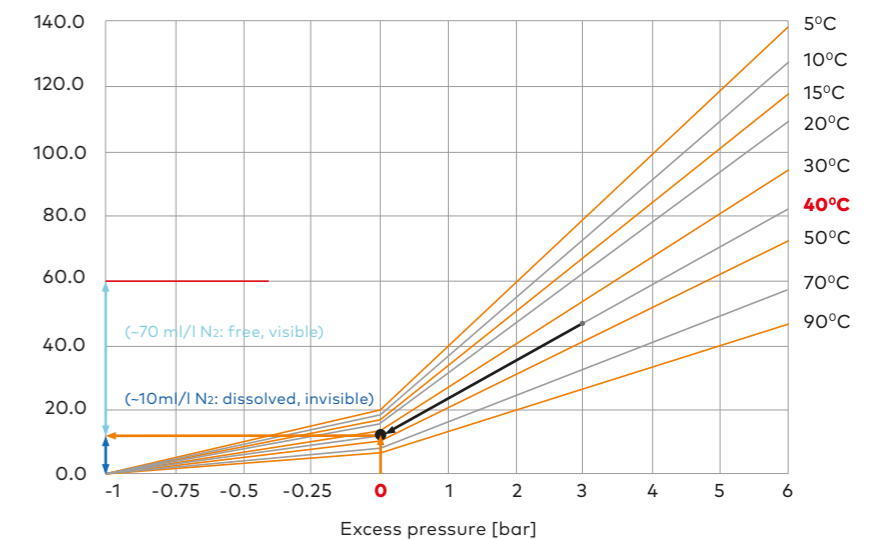

Pressure step degassers use a pump to reduce the pressure to below atmospheric pressure. Dissolved gases come out of the liquid in the form of microbubbles, which can then be vented into the atmosphere.

Gas Content when Filling, Commissioning and Operating the System

The gas content of a heating system is subject to strong fluctuations when passing through the initial filling, start-up and operation phases.

The following table shows the gas content of heating systems that is often found in practice. It can be seen that complete deaeration is possible only after the system has been heated up, which is often not done in practice. This means that the nitrogen released from the solution at the high points of heating the supply line will form gas cushions and circulate in the heating circuit in the form of free gas bubbles. As a consequence, the energy efficiency of the system is reduced, protective layers are removed by erosion, oxygen corrosion is promoted and disturbing flow noises are to be expected.



	Gas content of filling water	Gas content after filling and venting system [1]	During operation at typical flow temperature at top of system (0.5 bar / 70°C)
Nitrogen	14.8 ml/l (18.5 mg/l)	~ 40 ml/l (~50 mg/l)	11 ml/l (13.8 mg/l)
Desorbed nitrogen (free gas)			-29 ml/l (-36.25 mg/l)
	Gas content of the filling water	Gas content after filling and venting the system in the first few hours before corrosion has proceeded [1]	During operation
Oxygen	7.8 ml/l 11.3	-14 ml/l (-20 mg/l)	< 0.07 ml/l (< 0.1 mg/l)
Oxygen corrosion deposits			-64 mg hematite or -71 mg magnetite

Dirt and Mud in the Water

Dirt is unavoidable in heating and cooling hydronic systems, whether new or old



Causes prior to commissioning:

- existing dirt in pipes and components
- burr remains (particularly from plastic piping)
- welding and PTFE residues
- lubricants and sealants
- sand and dust
- residues from additives and inhibitors
- foreign items

Causes after commissioning:

Corrosion

The service life of waterborne heating systems is significantly affected by the service life of the metallic and non-metallic materials used in their installation. In the case of metals, what makes a difference is the construction and preservation of the thin protective layers of metal oxides on their surface, which inhibit corrosion processes.

What is corrosion?

Initially, the corrosion process comes to a standstill if the protective layer is well formed. The optimal resistance of the various materials' protective layers occurs under different chemical conditions, which is why certain materials (e.g. ferrous materials) facilitate corrosion protection. Copper materials can be easily integrated under "normal" conditions. Aluminum components require special attention with regard to water quality.

Corrosion itself is an electrochemical process within so-called corrosion elements, and is subject to local differences in the material, the protective layers and the water chemical conditions. The greater the differences, the stronger the corrosion element (corrosion potential) and the greater the risk of local corrosion. Uniform conditions lead to surface corrosion, which can be low enough to achieve the usual technical service life. This results in a loss of material. In (closed) heating systems, we are confronted mainly with wet corrosion.

The corrosion rate is also influenced by the electrical conductivity (LF) of the heating medium. A low LF hinders the flow of the corrosion current and a high LF (low electrical resistance) facilitates corrosion processes.

Protective layers can be damaged by chemical and physical processes. For instance, a pH value that is too low can dissolve the protective layers, and too much oxygen can "disturb" the usual protective layer formation (see VDI 2035 Part 1, 03/2021, Section 6). If protective properties are removed through mechanical (e.g. vibration or excessive flow) or thermal (alternating) stress, corrosion protection is no longer provided and the material corrodes locally. Defects in protective layers can corrode very quickly if large areas of the environment are protected and only small active corrosion points are present. The corrosion flow concentrates on the defects and leads to pitting corrosion.

Non-metallic materials usually fail due to incorrect treatment during installation (e.g. contact pressure for seals is too low), the impaired elongation or overstretching of polymers (which heat-stretch like metals), chemical influences (e.g. pH value of heating water and inhibitors is too high) or poor choice of materials.

What is rust?

Rust is a chemical compound of iron and oxygen. Rust formation is caused by oxygen, humidity, exhaust gases (sulfur), acids and alkalis. For instance, steel heating pipes that are in storage or under assembly can be affected by the air and rust.

Different types of corrosion and processes that affect the heating system

Stray currents

These are generated by direct current sources. Installations and underground pipelines and tanks can cause damage in a short space of time. For example, 1 mA can destroy roughly 10 grams of iron (Fe) in a year. Expert installation of protective conductors and equipotential bonding can resolve this.

Crevice corrosion

Poor "hemming" of sealing points and joints can cause crevice corrosion. Different oxygen distributions can be the cause.

Stress corrosion

This type of damage occurs when mechanical stress on system components leads to stress cracks. For example, tensile stresses can arise from construction (welding, bending, machining, etc.) or operation (pressure, temperature, movements, etc.). In stainless steel installations, stress corrosion cracking can also occur under certain circumstances in the presence of tensile stresses and critical chloride values. The remedy is to ensure that, during plant construction, pipelines, expansion joints and any apparatuses are correctly installed and allow for expansion.

Erosion corrosion

Erosion tends to occur at points with high flow velocities and in deflections (e.g. pipe bends). The smaller the pipe diameter and the narrower the pipe bend radius, the greater the erosion effect. In the case of insufficient degassing, the free gas bubbles circulating with the water increase the risk of erosion.

Deposition of corrosion products

In heating systems, solids can be deposited where flow velocities are too low to transport the particles further. Further deposits can then be made at these points and impede circulation.



Cavitation

Cavitation describes the formation and subsequent implosion of vapour bubbles in a liquid. Vapour bubbles form when the pressure falls below the saturation pressure of the liquid. This happens in water-borne systems when the static pressure falls below the saturation pressure at points of increased flow velocity (e.g. the pump suction orifice, valve seats and orifice plates). If the static pressure increases again further on in the flow (downstream pressure stages of a pump, speed reduction behind the valve seat), the steam bubbles can implode abruptly. Material directly adjacent to the steam bubble is eroded by the water flowing into the steam bubble from all sides with a strong "pattering" noise (high-frequency microscopic steam impacts). Gases dissolved in the water dampen the cavitation, because the gases desorbing into the steam bubble area do not suddenly return to a solution when the pressure subsequently builds up and buffer the water shooting into the bubble.

The most critical component in the system with regard to cavitation is the circulation pump. The static pressure on the suction side of the pump must not fall below the pump-specific NPSH value, otherwise cavitation processes will inevitably take place in the pump. In case of permanent cavitation, the pump will be destroyed after a relatively short time. But valves can also suffer damage and even fail under cavitation. To avoid cavitation in valves, the rule of thumb is that the pressure at the inlet of the valve should be two times greater than the pressure drop across the valve.

Heating systems with mixed materials

When using mixed materials, (e.g. various metals, plastic pipes, elastomer connecting hoses) there is only a small risk of oxygen corrosion as long as the oxygen content in the heating water is below 0.1 mg / l. Oxygen contents of 0.02 mg/l and lower are usually found in the circulating water of corrosion-proof systems (VDI 2035 03/2021, Part 1).

Galvanised pipes

The internal installation zinc-galvanised pipes should be avoided. Galvanised screws and nuts can be used, however, as they do not come into contact with the system water.

Glycol in closed circuits

The use of antifreeze in heating systems is normally not recommended due to its additional investment cost, the reduction of specific heat and increased pumping costs compared to pure water. Therefore, use antifreeze only in systems where the medium must be protected against solidification, e.g. solar or geothermal probe. When antifreeze is being used in closed circuits, the guideline values of the product suppliers must be observed. Decreased glycol concentration can lead to glycol being converted into oxalic acid. This in turn causes a drastic drop in the pH value. The result is corrosion. Also, internal galvanised steel pipes and fittings cannot be installed in circuits that contain antifreeze.

Consequences, Problems & Damages

Rust resulting from corrosion in boilers, pipes and terminal units reduces the specific heat transfer and increases the pressure drops and fluid velocity in the hydronic system. Note that rust causes the volume of iron to increase, leading to smaller cross sections in hydronic systems

Effects on internal pipe surface include:

- increased roughness
- decreased internal diameter
- direct corrosion
- deposits of corrosion by-products and other impurities

Due to the increased flow velocity, erosion takes place in pipes, singularities and valves through the circulation of small air bubbles and sludge particles.

Magnetite is a magnetic material that lodges on steel. It can damage or even destroy critical components, especially high-efficiency wet rotor pumps with permanent magnet motors.

Malfunctions can occur in thermostatic and other control valves as the magnetite sludge is deposited on the valve seat, preventing the valve from working properly.

In the case of underfloor heating systems, rust (e.g. magnetite) can result in the formation of a coating on the pipe interior, resulting in heat transfer being reduced and the supply temperature having to be raised. In extreme cases, individual heating circuits can become completely clogged and consequently fail.

Strainers quickly become clogged by corroded particles and thereby reduce throughflow. The positive effect of filtering the magnetite can then cause the system to fail. Strainers must be cleaned more often, increasing running costs.





Gases

Circulatory disorders

Free gas bubbles can significantly impair circulation. The capacity of the heat transfer medium is reduced – where there are gas bubbles, there can be no water. Furthermore, unstable flow conditions at flow-related and thermally exposed locations can lead to operating faults.

The result is reduced pump delivery performance or even failure, as well as the unstable behaviour of control valves, especially in low-load operation.

Noises

Free gases create noise in the system. This means flow noise in pipelines, fittings and valves, as well as "gurgling" radiators on upper floors.

Reduced heating capacity

Gases can have a negative impact on heat transfer.

This means reduced heating power due to the insulating effect of the gas bubbles on heating surfaces.

Extreme air accumulation can lead to the failure of radiators on upper floors, resulting in the stoppage of circulation.

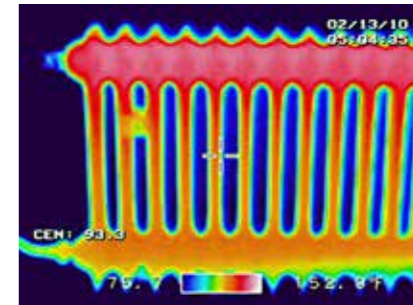

Fully vented radiator

Leaking radiators and system components

Damage to heating appliances, poor heat transfer as a result of obstruction, and deposits can lead to cracks and corrosion damage

Blocked control valves

Damage to valve spindles and sealings

Blocked pumps

Blockage and damage to bearings and glanding sealings of pumps

Clogged pipes

When pipes become clogged due to fouling and corrosion residues, there is a consequent increase in pressure drop as the same flow rate

has to flow within a much smaller free cross-section, considerably increasing pumping energy consumption.

Heat exchangers

An insulating layer with a negative heat transfer influence is generated at heat generators and heat emission points which can overheat boilers and heat exchangers and thus cause damage.

Heat meters

Magnetite builds up in heat meters, which leads to increasingly inaccurate measurements, to the point that the system can be blocked or put out of service.



Water Quality According to VDI 2035

In accordance with VDI 2035 Part 1, 03/2021, the maximum hardness of heating water and make-up water is determined in relation to the power and specific volume of the system: total hardness is relative to the specified system volume v_A (system volume/smallest boiler power)

Filling water, make-up water and heating water relative to heating output			
Total heating output, kW	Total quantity alkaline earths, mol/m ³ (total hardness, °dH)		
	Specific system volume, ℓ/kW heating output a)		
	≤ 20	> 20 to ≤ 40	> 40
≤ 50 kW specific water content heat generator ≥ 0.3 ℓ per kW b)	none	≤ 3.0 (16.8)	
≤ 50 kW specific water content heat generator < 0.3 ℓ per kW b) (e.g. circulating water heater) and systems with electrical heating elements	≤ 3.0 (16.8)	≤ 1.5 (8.4)	< 0.05 (0.3)
> 50 kW to ≤ 200 kW	≤ 2.0 (11.2)	≤ 1.0 (5.6)	
> 200 kW to ≤ 600 kW	≤ 1.5 (8.4)		
> 600 kW	< 0.05 (0.3)	< 0.05 (0.3)	
Heating water, independent of heating output			
Mode of operation low-salt c) containing salt	Electrical conductivity, μS/cm		
	> 10 to ≤ 100		
	> 100 to ≤ 1500		
Materials in the system	Appearance: clear, free of sedimenting substances		
	pH value		
	without aluminium alloys	8.2 to 10.0	
	with aluminium alloys	8.2 to 9.0	

Condition of filling and make-up water

- a) When calculating the specific system volume, the smallest individual heating output is to be used in systems with several heat generators.
- b) In systems with several heat generators having different specific water contents, the smallest specific water content will apply.
- c) Full softening is not recommended for systems with aluminium alloys.

Softening

During softening, the filling water is passed through an ion exchanger. The resin contained therein absorbs calcium and magnesium ions from the water and exchanges them for sodium ions. Unlike calcium and magnesium, sodium is not a hardener. The resulting filling water usually still has a certain hardness but this hardness does not create limestone. The conductivity of the water remains almost unchanged.

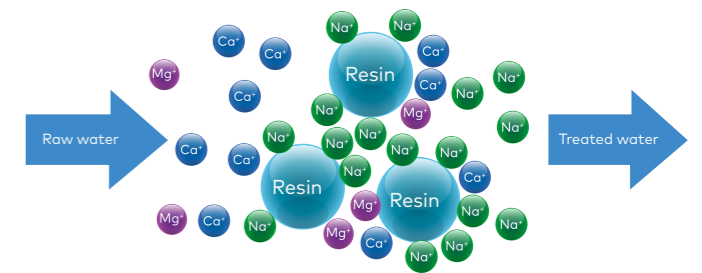

Demineralisation

Drinking water should be used as filling and make-up water in hot-water heating systems provided the total quantity of alkaline earths meets the requirements of table above. When the water quality varies, the highest values must to be taken.

During demineralisation, all salts are removed from the filling water. This also reduces the electrical conductivity of the water and effectively prevents corrosion. To remove these dissolved (dissociated) ions, special cation and anion exchange resins are used. These absorb the ions dissolved in the water and release equivalent amounts of other ions of the same charge to the water.

The cations dissolved in the water (e.g. Mg⁺⁺, Ca⁺⁺, Na⁺ and K⁺) are exchanged by the cation exchange resins for H⁺ ions, and the anions (e.g. Cl⁻, NO⁻ and SO₄⁻) by the anion exchange resins for OH groups. The result is pure, fully desalinated water.

If the ion exchange resins are saturated (exhausted), they can be reactivated by reversing the loading process with suitable regenerating agents at the manufacturer.

Demineralisation of the filling water with the help of mixed-bed resin cartridges can reduce the electrical conductivity to less than 10 μS/cm. In the praxis the electrical conductivity increases rapidly in the system and stabilises at electrical conductivities below 100 μS/cm (low-salt mode of operation).

The pH value of the filling and make-up water is usually around pH 7.0 and thus well below the pH value recommendations for the circuit water of the heating system. Since the pH value of the heating water usually increases within a few weeks of operation due to its self-alkalisation, an alkalinisation of the filling and make-up water is not necessary if the pH values are too low.

Required pH range for different materials

- pH value should be in the alkaline range between pH 8.2 and pH 10.0 to avoid corrosion
- pH value influences the natural protection oxide layers on metal to reduce corrosion
- When using aluminium components (heat exchangers, boilers, radiators) in closed water circuits, special attention must be paid to the correct pH value range so that damaging corrosion processes are prevented. The corrosion behaviour of the aluminium components depends very much on its alloy type. Normally, a pH value range of 8.2 to 9.0 should be maintained. The manufacturer's instructions must be observed.

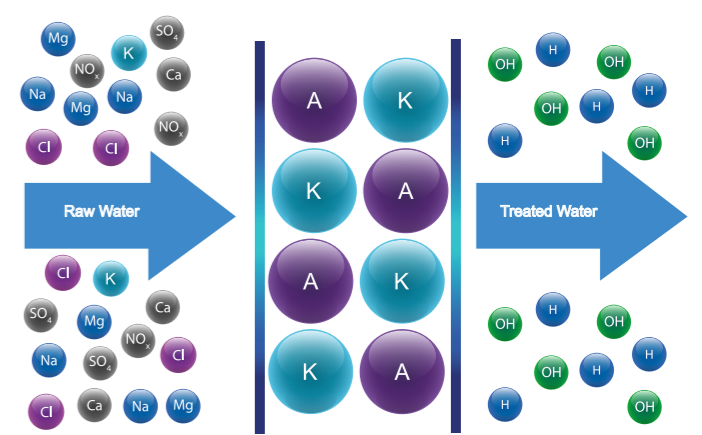

Pleno Refill Demin

Venting and Separating Free Gas Bubbles

Removing free gas bubbles from a closed water circuit always involves separating the free gases from the liquid into a quiescent zone and discharging the collected gases into the ambient air

Principle of automatic air vents

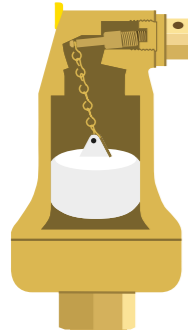

Automatic air vents automatically discharge accumulated gases to the outside. The water must be still. Otherwise the gases will be carried along by the flow and cannot enter the air vent. Usually, in automatic air vents, an air release valve is float-controlled. First, free gas bubbles rise past the float into the upper area of the air vent and the float sinks down with the water level. At a certain float position, the air release valve opens and the accumulated gases escape into the environment. As the float rises, the air release valve closes again. Preferred applications are the initial deaeration during the filling of systems, decentralised deaeration of radiators and aeration during emptying.

Essential quality aspects of automatic air vents

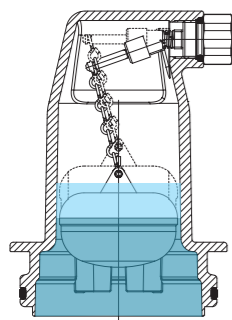

In order to guarantee the permanently perfect functioning of the automatic air vent, it is essential that dirt and water are kept away from the air outlet valve even at high pressures. With Zeparo, this is ensured by maintaining sufficient distance between the water surface and the valve outlet and as well as by the baffle plates below the float, which prevent water from rushing up into the air vent too quickly.

In addition, it is very important for the float to have stable guidance in a sufficiently large and flow-balanced chamber.

A sufficiently large connection to the installation is required so that even large gas bubbles can rise into the deaerator without getting stuck at the inlet due to capillary effects. Even with compact air vents, a minimum size of half an inch should not be undercut.

Problems with air vents when essential aspects of quality are disregarded

The cause of leakage at the air separators is too short a distance between the air valve and the water level, with the result that water mist from air bubbles is deposited on the air release valve when they break through the water surface. As this mist also contains dissolved salts, incrustations form and the air release valve becomes leaky.



Example of poor-quality air vents, which soon begin to leak due to their faulty construction

Positioning of air vents

Automatic air vents should be installed at the highest point of each riser in the system and at any point where air can gather. They should be installed vertically, with the connection at the bottom to ensure proper operation and efficient initial venting.

After the initial filling and deaeration, the system should be heated up so that further dissolved gases can desorb and, when the circulation pump subsequently stops, rise as free gas bubbles to the air vents and be expelled into the ambient air.

Air vents can also be mounted on the radiators. They are mounted at the highest level to vent them.

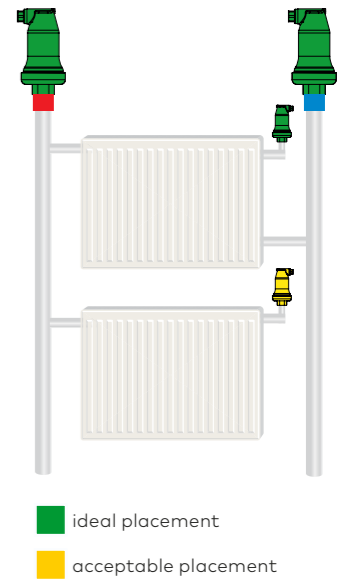

Air vent for operational venting

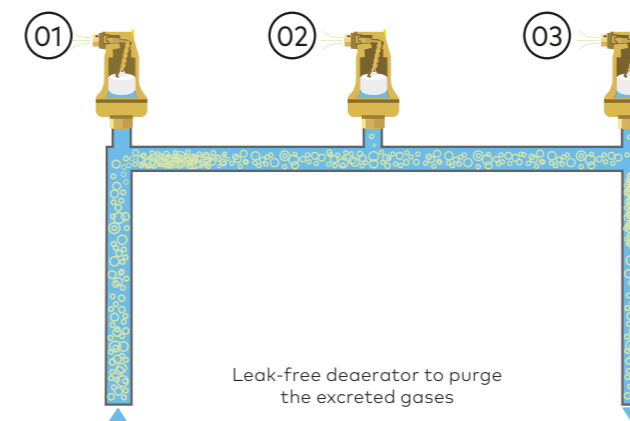

01 This is the worst case, with the bubbles almost completely entrained within the flow.

02 Only a few bubbles find their way into the air vent. Separation efficiency is low and relevant only at $d/D=1$ and flow speeds of $w \leq 0.5$ m/s.

03 Due to the turbulence in the bend, only a few bubbles reach the air vent.

Air vents remove air very inefficiently and are not recommended for deaeration. Microbubble separators are a far better option.

Achievable gas saturation of air vents in relation to separators

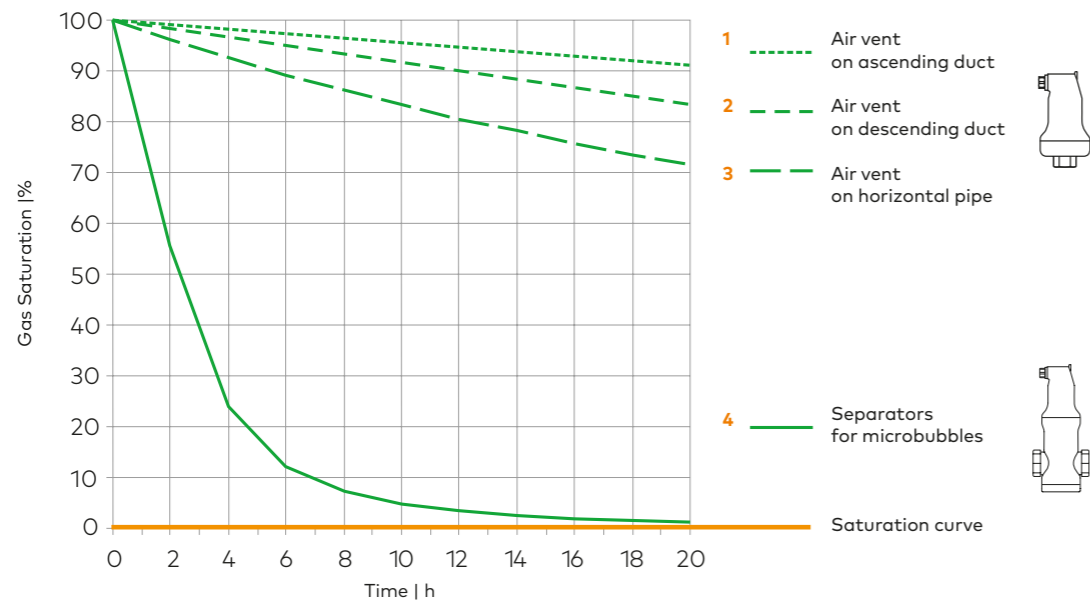

Comparison: gas saturation achievable with degassers and separators

The following separation principles can be found in the different solutions on the market:



Reduction of flow speed

Classic separators for air reduce the flow speed. Existing bubbles can rise to the top in calmer water and are separated. They are then expelled by means of an automatic air vent. The separation efficiency of these devices is low as they can catch only very large gas bubbles. Microbubbles are transported along with the flow.



Control devices

Baffles in a classic air separator should direct the air bubbles in the upper part of the separator. The effect of the adhesion of the smallest bubbles is low as the surface is small.



Centrifugal effect

The water can be set in rotation by tangential inflow and outflow. With the rotation of the flow the lighter bubbles tend to become concentrated in the middle and rise. For various reasons this principle is difficult to realise in the separation of microbubbles.

Coalescence effect

This is the adhesion of the smallest bubbles to other matter. The bubbles accumulate, cluster together and may then rise. This phenomenon occurs on specific rings (e.g. porcelain or ceramic) or on wire mesh.



Wire mesh has a combination of turbulent and calm areas. The bubbles collapse in the turbulent area below. Exchange occurs with the calm area above, where the bubbles may then appear.



There are several variants of wire mesh: horizontal or vertical, with or without a central core, and in the shape of a spiral, brush or sieve.

Helicoidal principle

This technology from IMI Pneumatex combines the principles above while avoiding their disadvantages:

- Flow rate is reduced such that large bubbles can rise very quickly.
- A large number of inclined wings redirect the bubbles upwards.
- The helicoidal separator (which has a large surface area) captures the microbubbles in an optimal way with its many wells and tips.
- The helicoidal arrangement (an upwards spiral) allows even the small bubbles to rise in the central column with little turbulence.
- Thanks to the improved flow technology, the bubbles form outside the main flow.
- The wings ensure a large calm area in the upper section of the separator, where bubbles can easily appear.

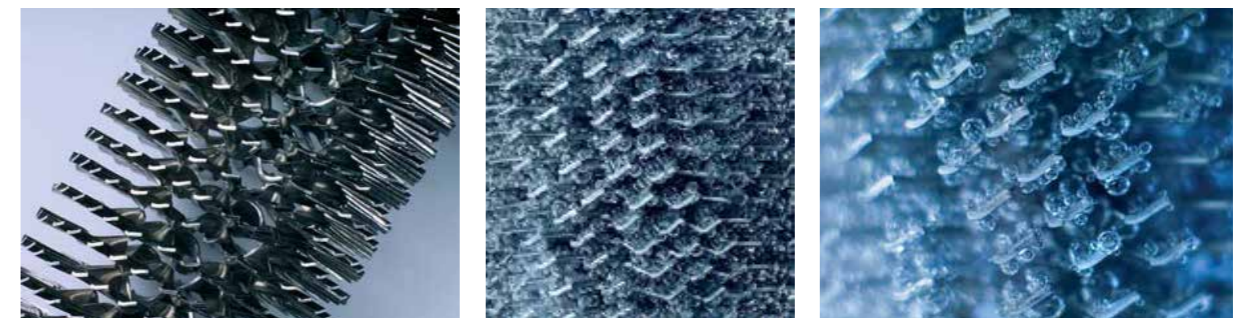

Microbubble separators

Separators for microbubbles can have a very compact design. They are suitable for operational degassing. Different separation principles can be combined to increase efficiency. The separator is completely flow-through. Gases are separated from the water and vented through the air vent.

Microbubble separators become increasingly efficient as static height (Hst) goes down and system temperature (tmax) at the installation point goes up. Effectiveness is limited by static height (Hst) above the separator (see table below).

tmax	°C	90	80	70	60	50	40	30	20	10
Hst	mWs	15.0	13.4	11.7	10.0	8.4	6.7	5.0	3.3	1.7

Hst = maximum static height for effective microbubble separation at maximum system temperature upstream of the separator

Zeparo ZUV microbubble separator



The professional solution with high separation efficiency in a compact design.

- Low flow speed inside the separator allows large bubbles to rise quickly
- Large number of baffles in a spiral arrangement redirect bubbles upwards
- Smaller bubbles can rise in the central column with little turbulence
- With its many recesses and peaks, the helicoidal separator has an extensive overall surface area which aids the coalescence of gas bubbles, capturing microbubbles in an optimal way. Coalescence is the adhesion of the smallest bubbles to another material. The bubbles gather together, form into bigger bubbles and then ascend



Under normal conditions, microbubble separators cannot achieve undersaturation at the point of installation. However, large parts of the system that are at higher pressures can become absorptive.

Two factors determine the efficiency of a deaerator: the efficiency of the separating element and the pressure drop that a separator causes.

A good separating element ensures that as many microbubbles are trapped as possible and efficiently removed from the heating system. In addition, the separating element must not form an obstruction to the flow in the system. A microbubble separator should preferably be installed at the hottest point in a system, where the microbubbles are released. In the case of a heating system, this is where the water exits the boiler or the separation plate heat exchanger.

Application of separators and pressure step degassers

Microbubble separators are passive devices that can vent only bubbles that are already present in the system and enter the separator. They are ideally positioned where pressure is low or system temperature is high, where bubbles are generated naturally. If static height (Hst) is exceeded, the gases remain in partially dissolved form and cannot be separated effectively.

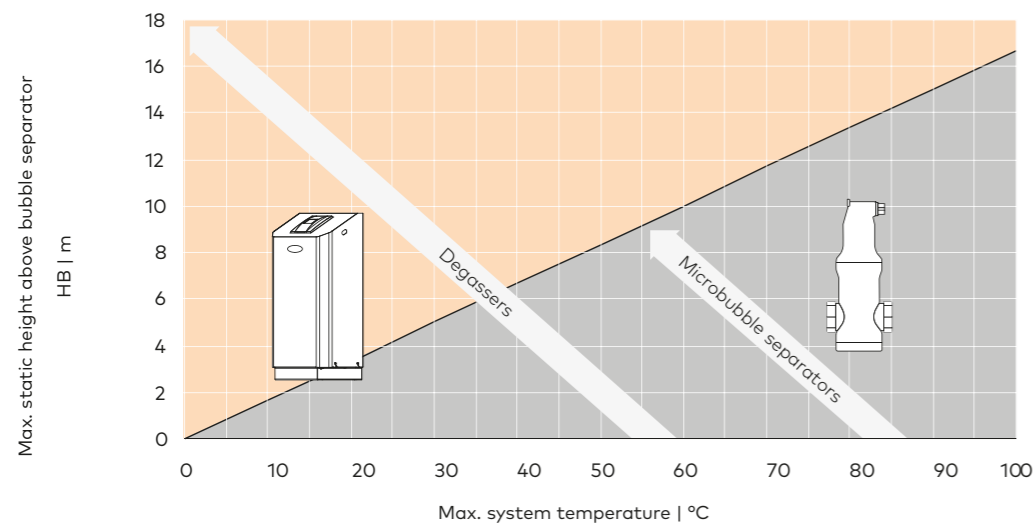

Microbubble separators are fully functional only below the line. Degassers that are capable of removing dissolved gases in addition to possible free gas bubbles are the solution when microbubble separators reach their physical limit.

Principles of Separation for Dissolved Gases

Degassers remove dissolved gases from the water during system operation in a partial flow. The principles used are targeted temperature increase and pressure reduction

Thermal degassers

Thermal degassers use higher temperatures to reduce solubility. Such systems are very energy-intensive and should be used economically only where hot water and steam are available.

For this reason, thermal degassers are almost never found in HVAC Systems.

However, thermal degassing effects at hot boiler walls can be used by means of a microbubble separator.



Pressure step degassers

Pressure step degassers use lower pressures to reduce solubility. Pressure step degassers have been used for a number of years to degas HVAC systems in buildings. The investment and operating costs of such degassers are negligible compared to thermal degassers.



The principle of degassing:

- Draw off a sample of gas-saturated water from the system and reduce the pressures. Dissolved gases will emerge from the solution in the form of microbubbles.
- Vent gas bubbles out into the atmosphere.
- Inject deaerated water back into the system.
- If this process is continuously repeated, the entire water content can be conditioned to be highly absorptive.
- A distinction is made between vacuum and atmospheric pressure step degassers.

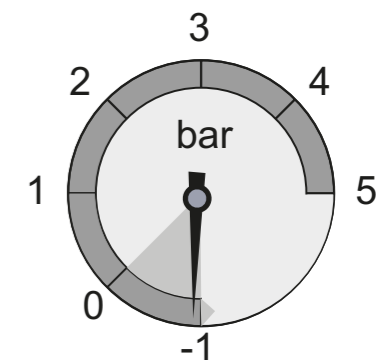

The efficiency of pressure step degassers depends on the pressure level (atmospheric, vacuum) and the efficiency of the coalescence effect (size of air bubbles).

Depending on the pressure difference, pressure step degassers can separate dissolved gases and achieve a state of gas undersaturation at every point in the system. Theoretically, total undersaturation up to 100% can be achieved in the vacuum. Atmospheric degassers can achieve roughly up to 15% undersaturation. The degassing effect is higher than in comparable microbubble separators.

In vacuum degassing, some of the system fluid is temporarily subjected to a vacuum. The gases dissolved in the fluid are released, separated and removed from the system. The degassed and absorptive fluid is then pumped back into the system where it can start circulating and gases

can be absorbed again. In this way problems can also be rectified in places where the flow is poor and overpressure is limited.

The greater the undersaturation of the dissolved gases in the medium, the greater the buffering capacity for gases that are introduced into the system (e.g. by make-up water, during repair work, system extensions, ...).

If we calculate with an undersaturation of 10 ml/l, a 400 kW system with a water content of 5,000 litres can take in an air volume of 50 litres without producing bubbles!

Vacuum degassers can lead even highly gas-supersaturated systems into a gas-undersaturated range very quickly.

In addition, vacuum degassers can also degas make-up water, which significantly reduces the oxygen load (usually 60-80%).

Vacuum degassers are therefore particularly suitable for:

- Systems with many branches and a low flow velocity
- Chilled water systems where a microbubble separator has only a very limited range of application due to the low system temperatures
- Systems with high system pressure
- Systems with regular and increased water make-up demand
- Systems subject to regular criticism related to "air problems" (cold radiators, flow noises)
- Systems in which gas content is to be reduced quickly
- Systems that require the highest possible energy efficiency, because optimum hydraulic balancing, optimum circulating pump performance and optimum heat transfer are possible only without gas bubbles

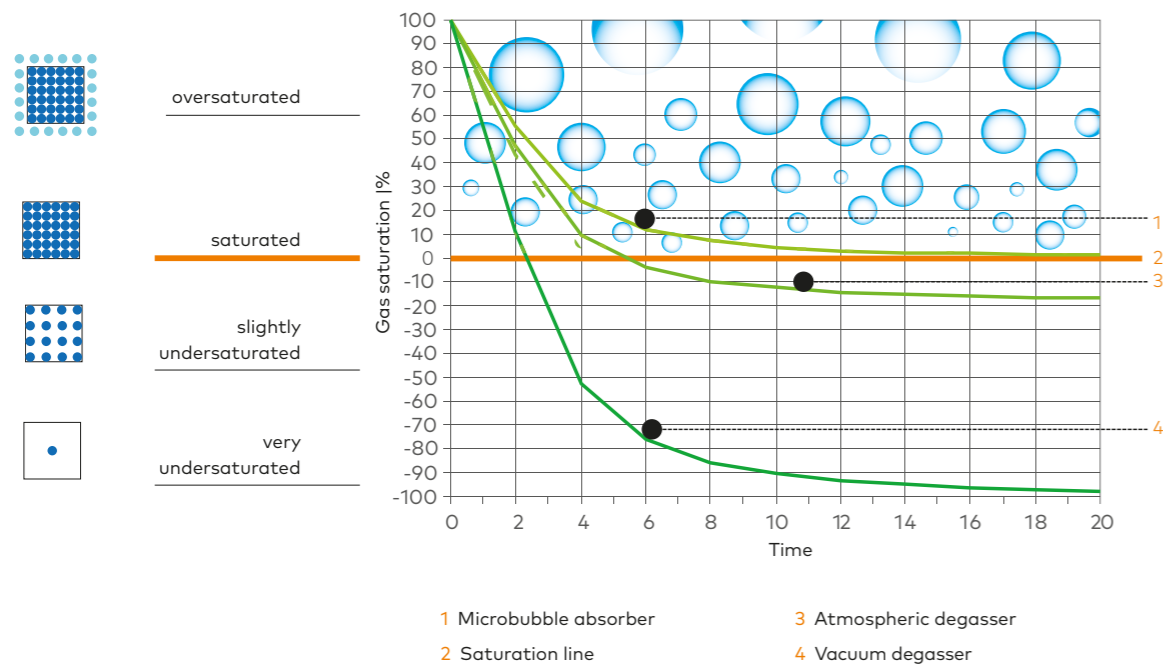

Atmospheric Degassing

The simplest way to implement atmospheric degassing is as part of a pump pressure maintenance system with a pressureless expansion vessel

With the pump and the overflow valve, a pump pressurisation system already has the essential components to realise partial flow pressure step degassing. In the pressureless expansion vessel, the system water is automatically expanded to a pressure level that is lower than any static pressure in the system. This is why the integration of degassing at atmospheric pressure is so simple here.

A particularly inexpensive and frequently realised form of atmospheric degassing is carried out directly via the expansion vessel of the pressurisation device. However, there are some very important points to consider.

O₂ admission can be prevented only with high-quality diaphragms, otherwise the system is only semi-closed. A disadvantage in flow-through at higher temperatures is that oxygen tightness of the diaphragm is reduced exponentially and the ageing increases. However, the expansion vessel used for degassing must be thermally insulated. Otherwise, the heat loss over the large vessel surface ceases to be negligible.

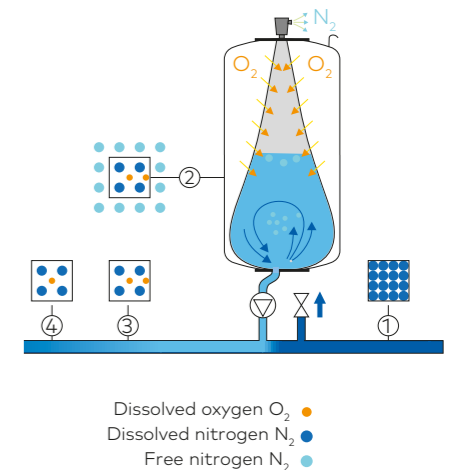

Atmospheric degassing inside the expansion vessel with oxygen diffusion through the membrane of the vessel

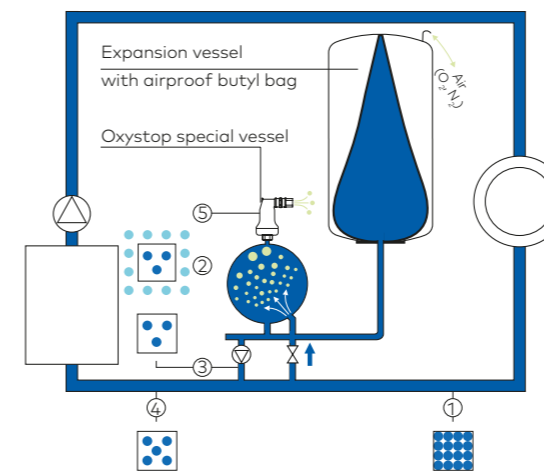

Improved Pneumatex solution with airproof technology. No degassing in the expansion vessel eliminates risk of oxygen diffusion

Pneumatex has improved on this principle with airproof technology. In this case the expansion vessel is not used for degassing and is always kept at low temperatures, without the high risk of oxygen diffusion. All of the degassing is performed in a separate diffusion-tight degassing vessel. Together with the airproof butyl bag, the risk of impermissibly high oxygen diffusion via the expansion vessel is eliminated. In the meantime, this Pneumatex atmospheric degassing technology has been replaced by the far more effective cyclonic vacuum degassing.

Vacuum Degassing

Different technologies can be used to create a vacuum and separate dissolved gasses from the media in the system

In vacuum degassers, a distinction is made between degassers with vacuum generation on the gas side and degassers with vacuum generation on the water side. The latter have the largest market share, as both acquisition and operating costs are very low.

Vacuum deaerator with water-side vacuum generation – operating principle

The main component of this degasser is a water-side high-pressure pump, which creates a vacuum in the degassing tank and conveys the degassed water into the connected system. Depending on the design, the water is fed into the degassing tank in the liquid area or in the gas area created by the negative pressure. The degassing process consists of a vacuum phase

and a flushing phase. In the vacuum phase, the outflow from the degassing tank is greater than the inflow, which creates negative pressure. As soon as there is negative pressure, the gases desorb from the liquid. In the flushing phase, the inflow is greater than the outflow. The vacuum is maintained for most of the flushing phase until, at the end of this phase, the desorbed gas is discharged to the environment at overpressure via the air vent.

The efficiency of degassing depends on the process used, as this how well the microbubbles desorbing in the vacuum can be guided to the air vent without being carried back into the system by the pump flow.

IMI Pneumatex cyclonic vacuum degassing

The current pressure step degassing units of IMI Pneumatex use a unique combination of cyclonic effect and vacuum degassing. IMI Pneumatex cyclonic vacuum degassing is an extremely compact, scalable and maximally efficient vacuum degassing technology. It replaces the Pneumatex spray-whirl vacuum degassing system produced until 2015.

How does cyclonic vacuum degassing work?

In cyclonic vacuum degassing, part of the medium is passed to a special degassing tank where it is exposed to strong negative pressure. An orifice in the inlet pipe limits the flow rate of the water to less than what the pump is able to deliver. This releases the dissolved gases inside the container.

The resulting fluid is milky in appearance because of the many tiny bubbles it contains. In conventional systems, the problem at this point is how to separate and expel these gas microbubbles from the medium. Various technologies are available, but none of them is particularly effective. IMI Pneumatex has devised a solution using revolutionary cyclone technology.

While a sludge and dirt separator was being developed on the basis of cyclonic technology, it became apparent that centrifugal forces in the Cyclone separator were causing the dirt particles to move outwards very quickly, whereas the air, being lighter than water, collected in the middle.

This phenomenon has been put to good use. The patented Cyclone vacuum degassing technology quickly concentrates the tiny gas bubbles in the middle, where they rapidly form larger bubbles that are very easily removed from a second tank. This method was used in a test series [3] in a 1.8 m³ cooling circuit to reduce the nitrogen content from 24.4 mg/l to 9.9 mg/l in the non-critical undersaturated range within 6 hours. Vacuum degassers that use other technologies sometimes need more than twice as long for the same reduction.

Cyclonic vacuum degassing technology is so efficient that even water-glycol mixtures can be degassed to very low gas contents in good time. Experiments [4] have shown that vacuum degassers using other technologies either cannot degas the medium at all or do so only marginally in an ethyleneglycol-water mixture.

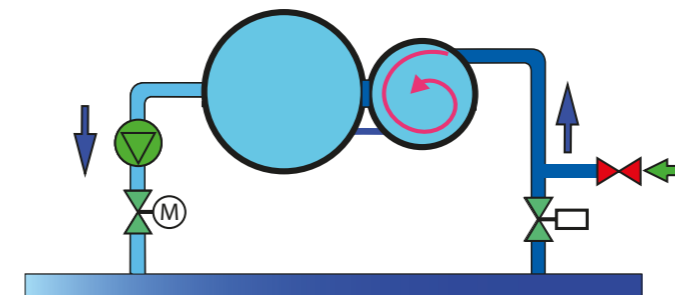

View from the top of the vessel

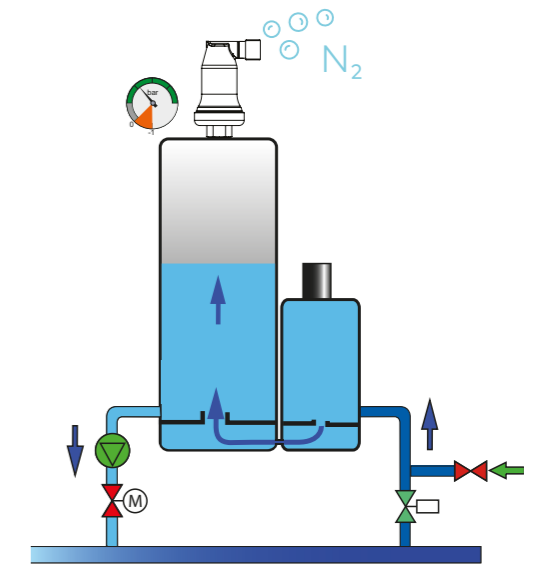
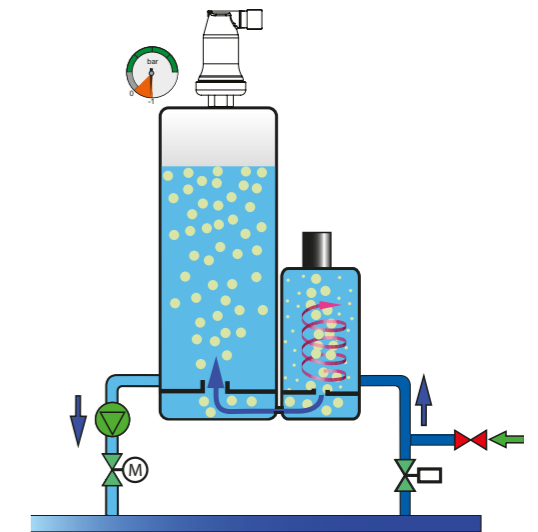

Small cyclonic vessel with tangential inlet for cyclonic gas separation

The degassing process is controlled by a motorised ball valve on the pump pressure side. Depending on its position, the flow rate of the running pump ranges from 0% to 100%, allowing for the perfect set-up of the vacuum and flushing phases. Switching the pump on and off is not necessary in this process, which consistently avoids pressure peaks between the degassing phases and allows the pump to work practically wear-free.

Cyclonic vacuum degassing occurs in a stand-alone unit in the IMI Pneumatex Vento Connect product range. Vento Connect can be connected in parallel for higher performance and operated

with any type of system pressurisation, either with stand-alone pressure monitoring together with static expansion vessels or together with pressurisation devices that do not have system degassing or make-up water degassing, such as compressor-controlled pressurisation.

Cyclonic vacuum degassing technology allows for compact degassing vessels that can be integrated into pump pressurisation systems simply and economically. This integration has led to the creation of the IMI Pneumatex Transfero TV Connect pump pressure maintenance system.

IMI Pneumatex pressurisation with integrated cyclonic vacuum degassing

The IMI Pneumatex Transfero TV Connect series demonstrates the successful integration of cyclonic vacuum degassing into a pump pressurisation system. The vacuum-tight motorised ball valve between the pressureless expansion tank and the degassing vessels is the key element of this Transfero series and thus the key distinguishing feature of Vento hydraulics.

During the degassing processes, this motorised ball valve is consistently closed, opening only for the pressure-maintenance function. The sophisticated BrainCube Connect control system ensures that the pressurisation, vacuum degassing, water make-up and water treatment processes run smoothly and are monitored.

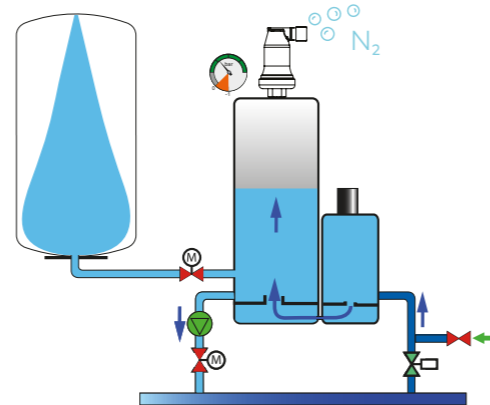

Gas content decay curves for concrete measurements

Vacuum degassing - 1.8 m³ cooling circuit - water

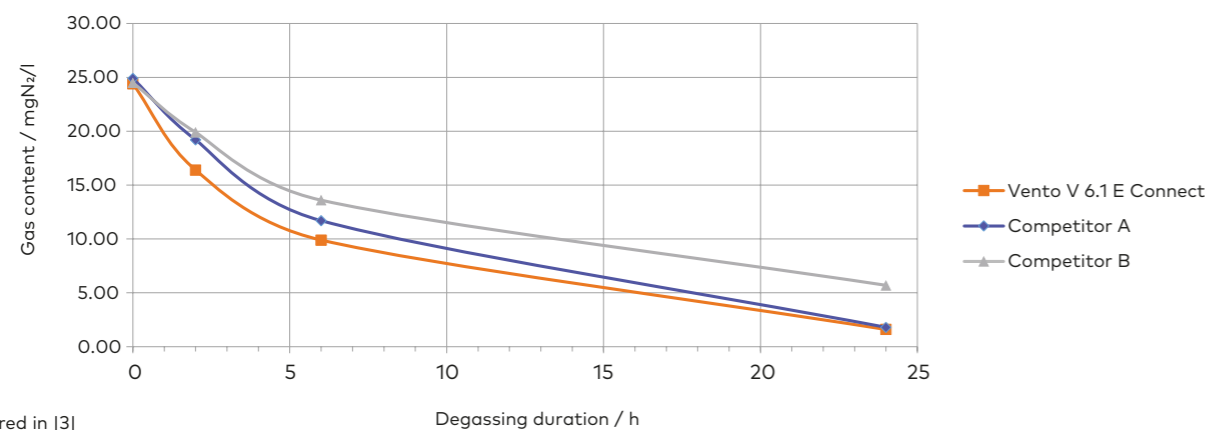

Measured in [3]

Vacuum degassing - 450 l cooling circuit - water with 25% ethylene glycol

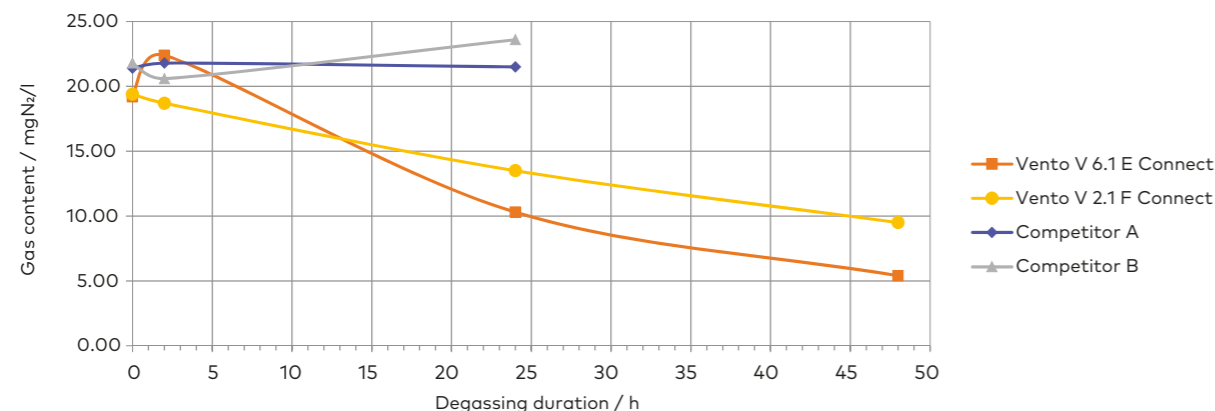

Measured in [4]

Tests for competitors A and B were stopped after 24 hours because no degassing effect was visible. Increased measurement values can be explained by the subsequent dissolution of N₂ gas bubbles in the circuit.

Degassing programs

Eco-auto operation: optimised gas content dependent on degassing operation

The PSeco switch for detecting exhaust gases is factory set to keep the nitrogen content below 8 ml/l. The eco-auto mode is the most energy-efficient degassing mode. Therefore, eco-auto is the factory setting for Vento / Transfero TV Connect after start-up.

Continuous degassing: quickly reduces gas content in system water

The unit degasses the system water in a time-controlled and continuous manner outside of nighttime rest periods. BrainCube calculates the required duration of degassing according to installation size. The calculated degassing time ensures a sufficiently low level of gas content in the system. Time remaining is indicated on BrainCube. The unit switches automatically to eco-interval degassing when continuous degassing is complete.

Eco-interval degassing: keeps the gas content in the system at a constant low level

The unit degasses the system water in a time-controlled manner and at intervals. The BrainCube control calculates pause times and degassing times according to system volume. This ensures constant low gas content with low energy consumption in each individual installation.

Water make-up degassing: reduces gas content in the make-up water by up to 80%, activated automatically for each water make-up sequence

Automatic vacuum tightness test

Vento and Transfero TV Tecboxes are equipped for high vacuum output. During each degassing cycle, continuous vacuum testing prevents air ingress due to malfunction. If the vacuum is interrupted, degassing stops automatically. In addition, the Vento automatically performs a two-minute precision vacuum test at night when the degassing function is inactive. It draws a deep vacuum and uses a tolerance of 0.05 bar to check whether the vacuum is stable.





This means even the smallest leaks can be detected, which may result from ageing seals or crystallisation on sealing surfaces after a few years.

If the vacuum does not work as expected, degassing is stopped immediately and an error message is issued. The automatic vacuum tightness tests ensure that the Vento performs continuous deep and accurate degassing of the HVAC system.

This feature is not available from several competitors. Without it, an unwanted air intake via leaks (e.g. through a defective vacuum check valve), cannot be detected in time and result in harmful oxygen corrosion. This cannot happen with Pneumatex Vento and Transfero TV devices.

Installation of Air Separators

Positioning of air separators

-  Ideal placement for microbubble separator
-  Acceptable placement
-  Unacceptable placement
-  Use of a Vento cyclonic vacuum degasser is recommended.

Heating

Small heating systems

Wall-hanging gas boilers

The best position is the supply pipe after the gas boiler. These systems have low static pressure and the highest temperature occurs after the boiler's burner. Because the space is narrow, a Zeparo ZUVL or Zeparo turntable ZTV is typically used.

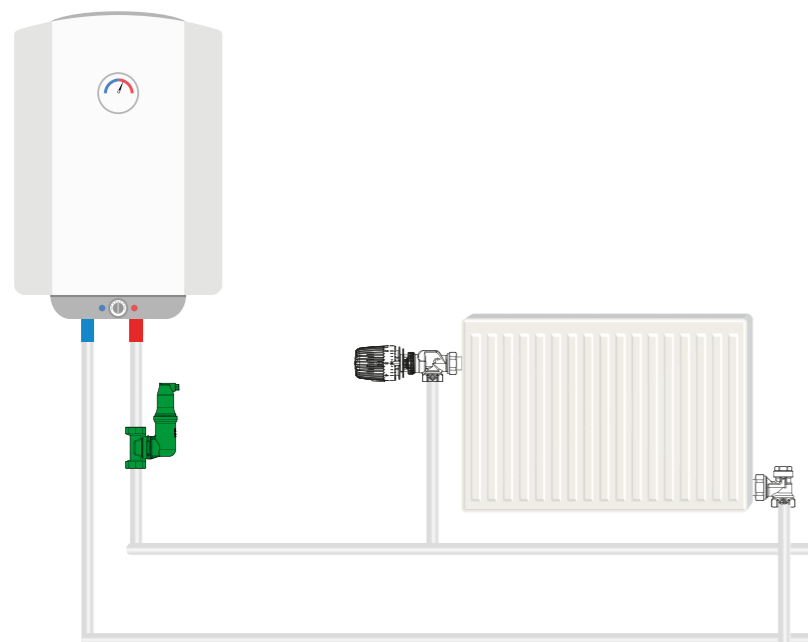

Radiator systems

The best position is the supply pipe after the boiler. These systems have lower static pressure and the highest temperature occurs after the boiler. The flow is variable after the hydronic separator, making it a good but not ideal position. The same is true of installation at the highest circuit, where there is low pressure but also lower flow. Installing microbubble separators on lower circuits or after the mixing point is not recommended, as temperatures are lower there.

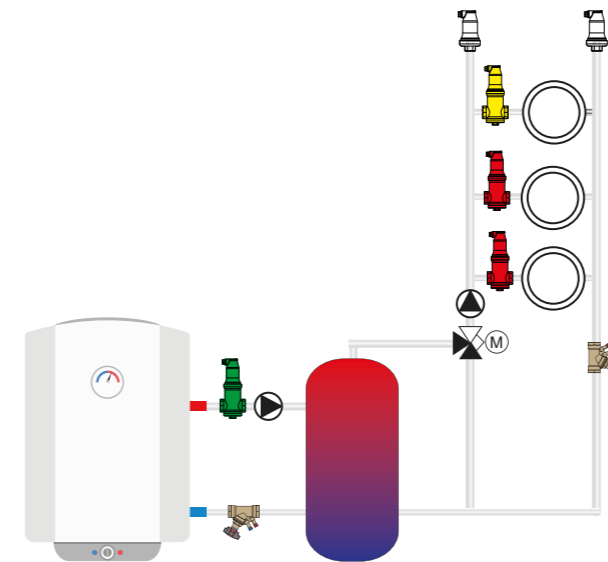
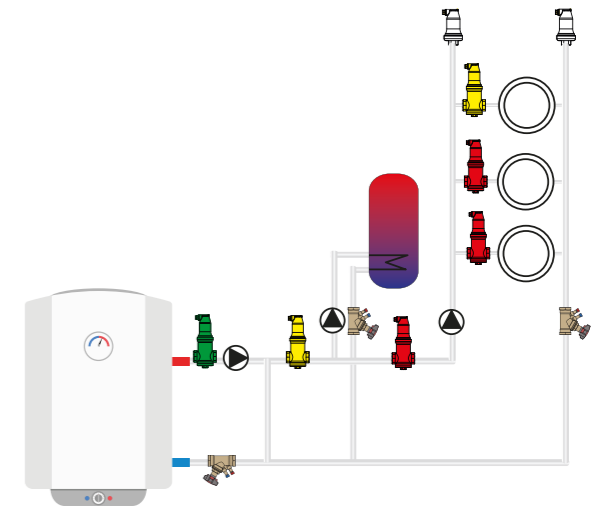

Radiator systems with domestic hot water tank

In principle, the same holds true. Due to the high temperature during tap water production and higher flows, positioning after the boiler is recommended.

Low temperature systems with heat pump

The best position is the supply pipe after the heat pump, a site with relatively low pressure and the highest temperature in the system, but because the temperature is still low, microbubble separation is limited.

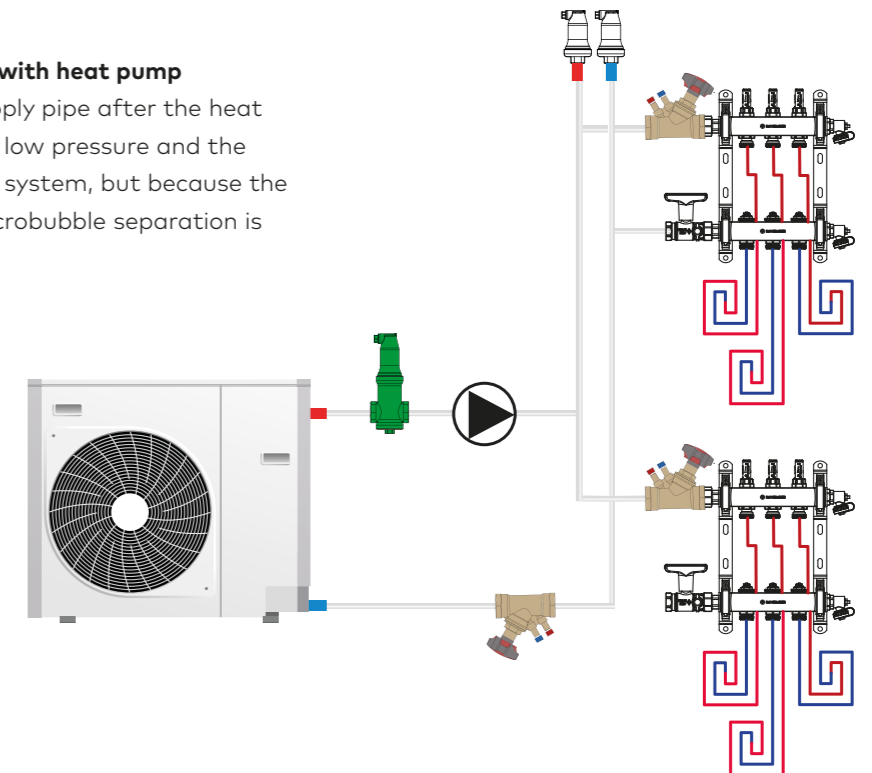

Large heating systems

Systems with risers

Due to the high static pressure in cellars, installation of microbubble separators is not recommended here. The best solution is to install a vacuum degasser. A vacuum degasser can keep the system free of air and gas problems.

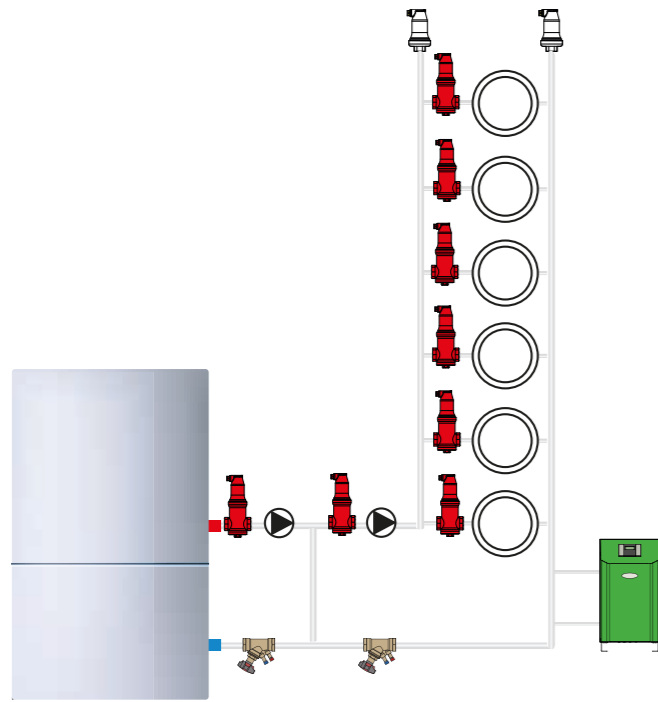

Systems on roofs

Here the best position is the supply pipe after the boiler. Systems located on roofs have the lowest static pressure and the highest temperature after the boiler. Therefore the position after the boiler is ideal. The second-best position is after the mixing point (control valve). Installation below this level is not advised. Due to the low static pressure in systems on roofs, good separation of microbubbles will be achieved.

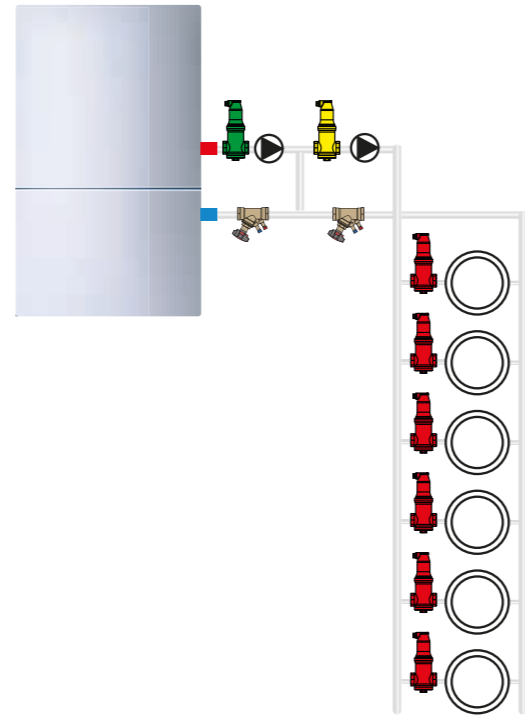

Small cooling systems

Cooling systems operate at low temperatures and thus offer poor conditions for microbubble separation as the dissolving capacity for gases in the medium increases. The best position for mounting a microbubble separator is in the return flow in front of the chiller, where the system's highest temperatures can be found. A much better solution, however, is to install a small vacuum degasser such as the Simply Vento.

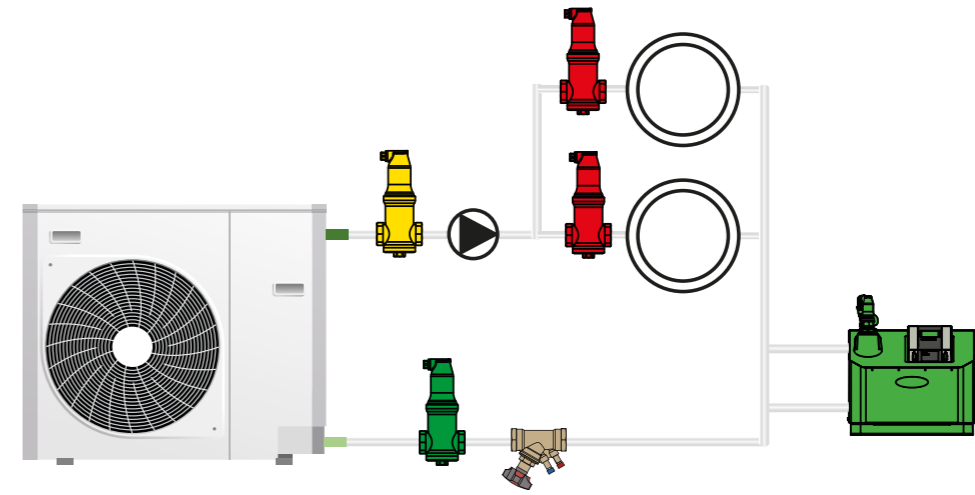

Large cooling systems

Cooling systems operate at low temperatures and thus offer poor conditions for microbubble separation as the dissolving capacity for gases in the medium increases. Due to the low temperatures and higher static pressure the use of microbubble separators is not recommended. Their efficiency would be very low regardless of the technology used. The best solution is to install a vacuum degasser such as the Vento Connect.

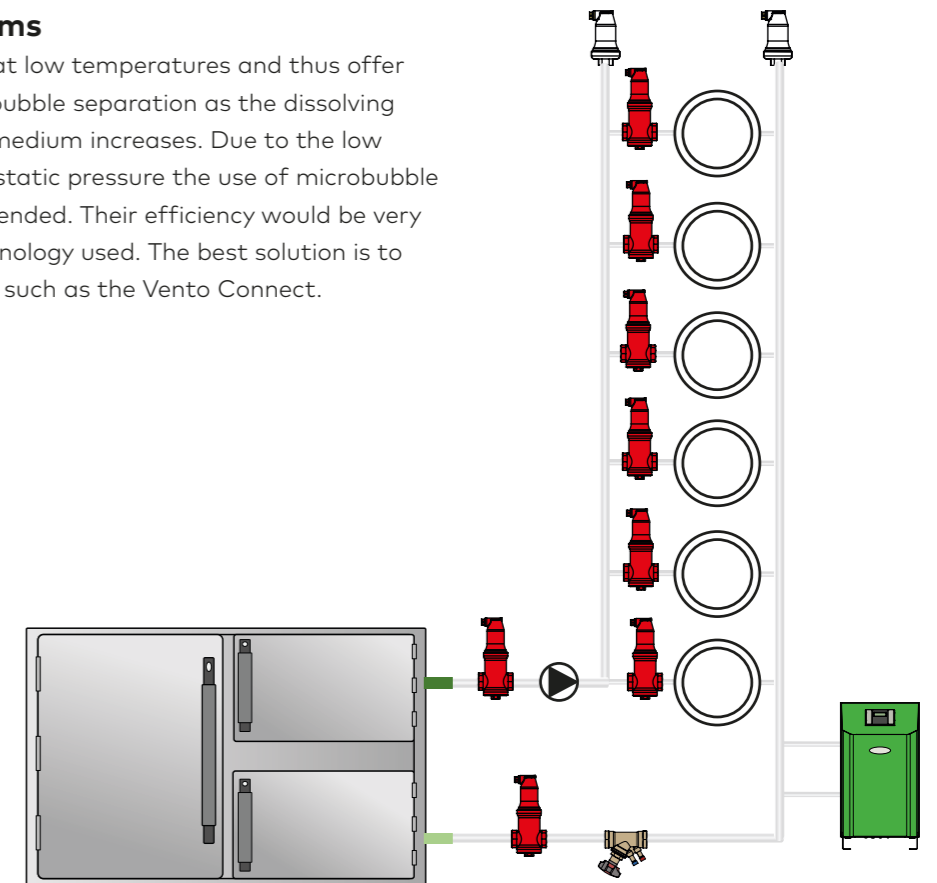

Solar systems

Solar systems are filled with water and glycol mixtures. This makes microbubble separation more difficult as effective separators must be used. The best place to achieve microbubble separation is after the solar panel in the supply pipe from the roof. Due to the higher temperatures that can arise, a special version of the Zeparo air separator must be used, Type ZUVS, which has stainless steel inserts.

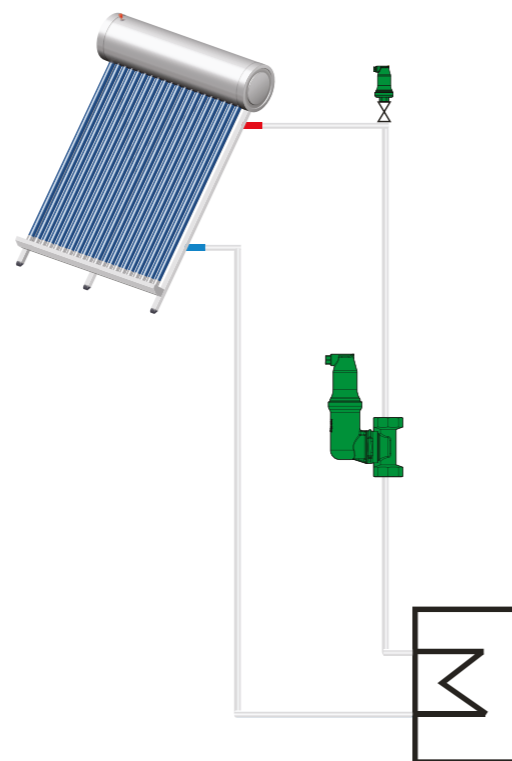

Mounting of Vacuum Degassers

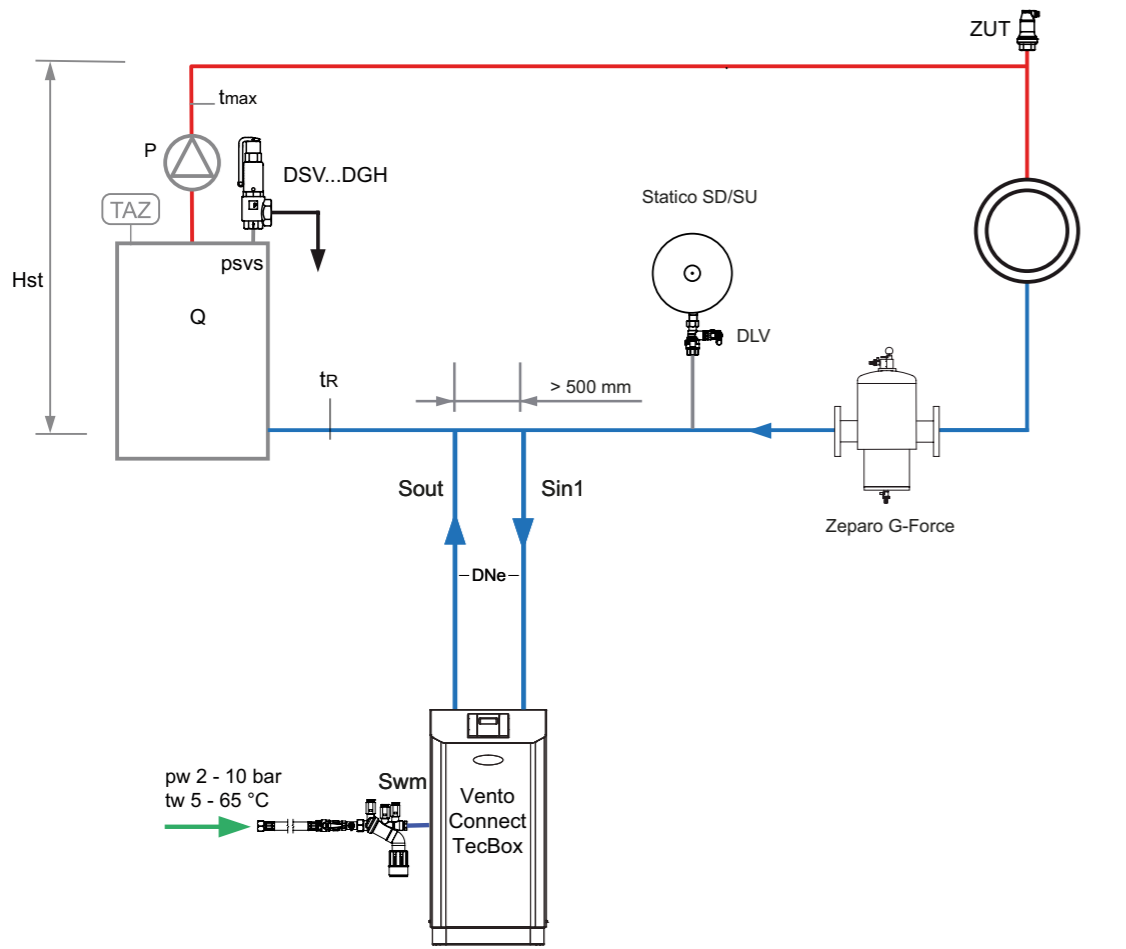

Example of heating systems, return temperature $t_r \leq 90^\circ\text{C}$

Installation is preferably carried out on the suction side of the circulation pumps, near the connection of the pressure control in the return flow.

Vento must be integrated into the main pipe of the system. Otherwise it is not guaranteed that degassing will be sufficient. Connections should be made in the direction of the flow in the following order: first to the branch to the unit inlet, Sin1, and then to the return branch from the unit, Sout. Ensure that there is at least 500 mm between the two connection points and that this is a straight pipe without any equipment installed between the filter, dirt separator, pump, etc. It should be a straight, empty section of pipe.

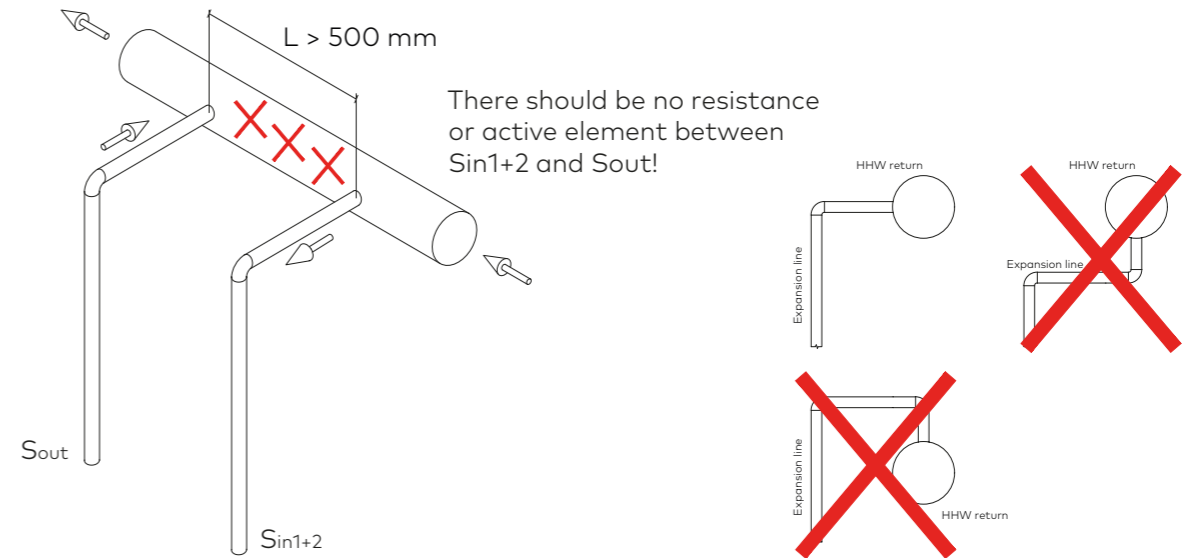

Furthermore, avoid overly long or twisting expansion pipes. Most importantly, avoid vertical loops, which are prone to having air pockets, especially in the case of Transfero TV and Vento V connect. If unavoidable, manual air vents must be installed on top of such parts of the piping.

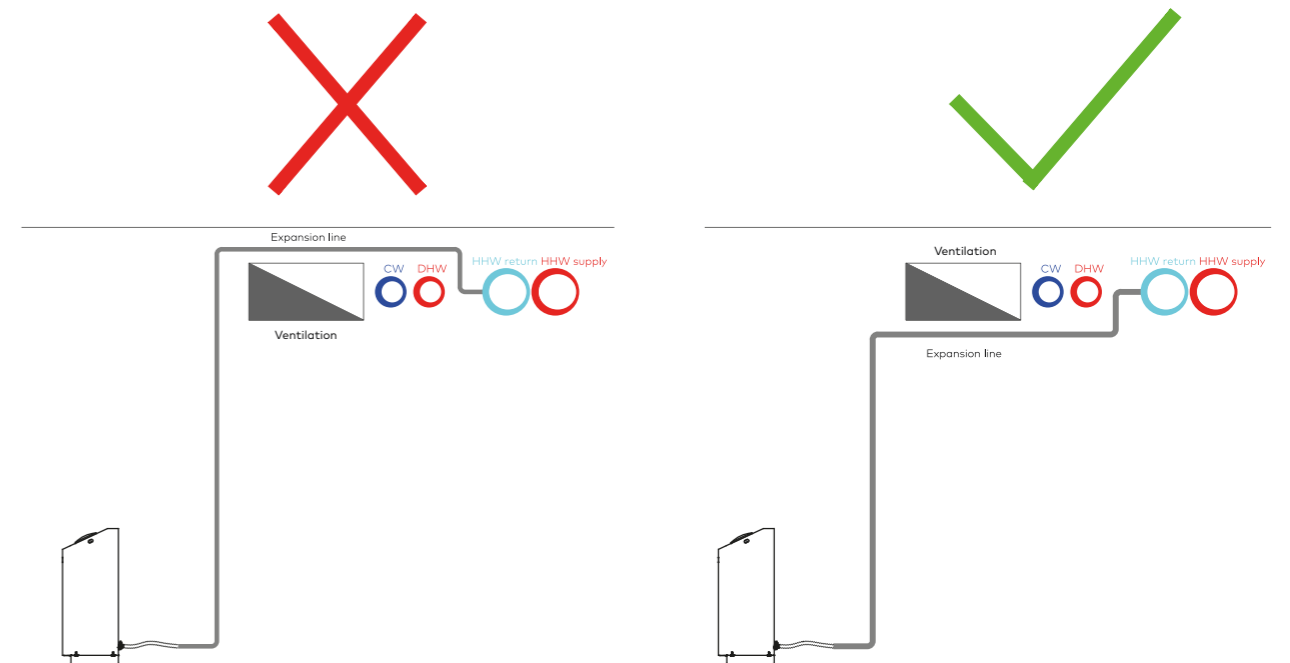

The connection DNe should be sized in accordance with the diameter required for the vacuum degasser and should contain flexible hoses to have a direct connection to the TecBox without tension.

Expansion vessels must have a minimum volume of 80 l.

Dirt Separation

Dirt and corrosion products can significantly reduce the efficiency and lifetime of HVAC installations

In the worst case, this can lead to complete failure of the system as plant components become dirty and the required flow can no longer be justified.

Dirt and sludge can be removed from the system with the help of suitable separators or filters. Different technologies are available on the market, but their efficiency varies and performance may be poor.

Dirt and sludge separators are devices that separate dirt and water mixtures present in the main flow into:

- a cleaner main outflow and
- a distinctly dirtier mixture that is left in the separator to be rinsed away

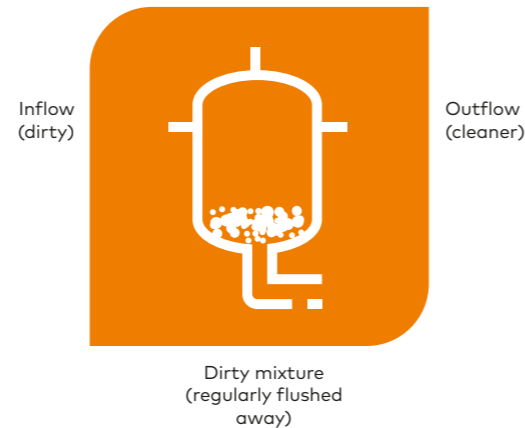

Separation principles for dirt separation

Filtration

Filtration captures the particles in the media. A sieve or fabric prevents the passage of particles of a certain size. Filters represent a compromise between efficiency and resistance. Efficient filters result in a very large pressure drop, and filters that result in an acceptable pressure drop are either very expensive or inefficient.

Depending on the mesh size, up to 100% of the constituents can be blocked, in which case we are talking about strainers, filters and filtration. The drawback to this solution is that the dirt generally blocks the throughflow. Cleaning is time-consuming and requires two shut-off valves.

All systems are fitted with strainers to protect equipment. Strainers are intended to capture large debris that might cause blockage or damage, such as foreign objects, metal fragments, jointing tape and large corrosion flakes. (None of this should be present in a previously cleaned system.) However, strainers do not retain fine particles of the metal oxides, scales or precipitates that contribute to the suspended solids resident in the system. Typically the element in the common in-line strainer will be either a perforated screen or a mesh screen (hole/mesh sizes larger than 0.8 mm).

It is counterproductive to specify a mesh smaller than actually needed as it will exacerbate the pressure drop and the risk of blockage of the strainer itself if not regularly inspected.

The difference between a filter and a strainer

The key difference between strainers and filters is the size of the particles they remove.

Strainers typically remove larger particles that are visible in a liquid or gas, while filters remove contaminants that are often too small to be seen with the naked eye.

Is it necessary to use strainers if dirt/sludge separators are installed in the system?

Yes, because the functions and operational principles of these devices are different.

Strainers can protect all equipment installed in HVAC systems against the damage and blockage caused by big dirt particles.

Dirt/sludge separators protect system components from the deposition of small dirt particles.

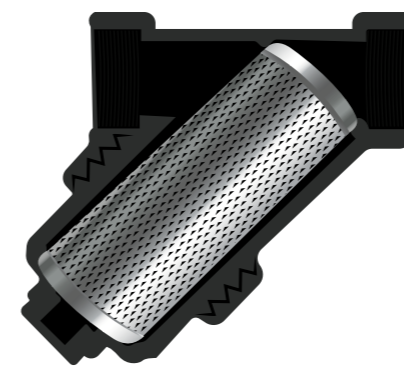

Strainer with mesh

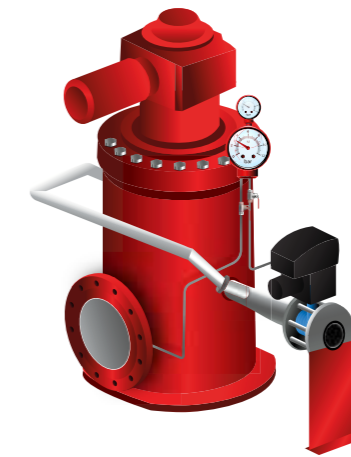

Automatic filter

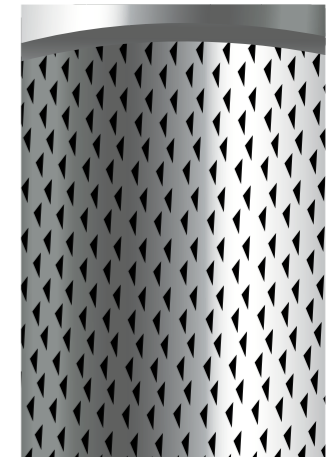

Filter basket

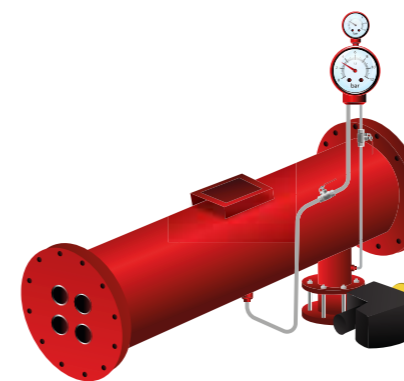

Automatic Jet Filter

A jet filter is a special type of filter. It can be automatically backwashed during operation, which makes it perfect for filtering in continuous such as primary water in heat pump circuits or cooling towers. As there are versions in stainless steel and various mesh sizes (50 µm to 5 mm), this type of filter can be used universally.

Mode of operation

Raw water enters the filter elements through the ports in the cartridge holding plate. Reducing the cross section leads to a proportional increase in the axial flow speed in the filter elements of up to 5 to 7 m/s.

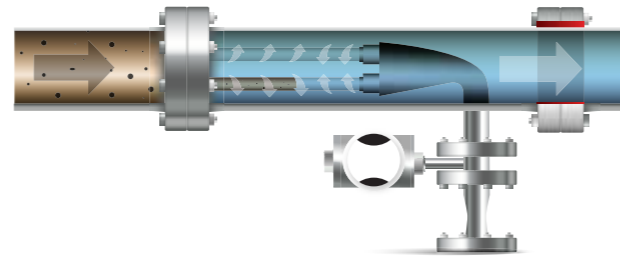

Located at one end of the filter elements is a conical common dirt collector.

In accordance with the rule of Bernoulli, the raw water filtration takes place in the last third of the filter elements. The raw water passes through the filter elements from the inside to the outside. The clean water then passes into the common collector and leaves the filter from the clean water side.

Because of the axial flow speed of 5 - 7 m/s in the filter elements, the dirt particles are discharged into the common collector. The backwash process is triggered by the differential pressure (the pressure difference between the raw and clean water sides). Additionally, an adjustable time lag relay in the electric control permits the start of the backwash process.

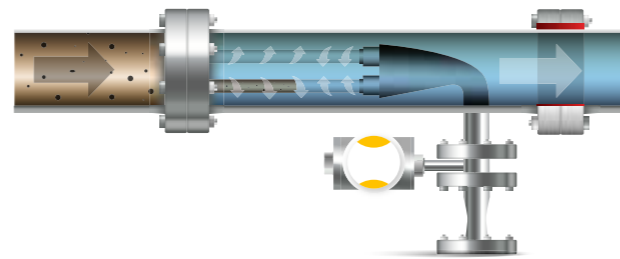

Backwash process

Filter cleaning begins with the opening of the motor-driven backwash valve. A small amount of raw water will flow through the backwash port and flush the dirt particles from the common collector from the filter. During the backwash process, the axial flow speed in the filter elements increases to up to 10 m/s. This high speed also serves to clean the filter elements. In addition, under pressure is produced in the filter elements, which guarantees that the elements are backwashed from the outside in with clean water. The backwash process takes 10 - 20 seconds, after which the backwash valve closes automatically. During the backwash the filtration process is not interrupted.

Sedimentation due to gravity

Classic dirt separators reduce flow speed. Dirt can slowly fall to the bottom, where it is separated. The separation efficiency of these devices is poor.

These separators are often larger vessels used in plants upstream of heat generators. However, deposited sludge must be removed regularly. Finer sludge particles cannot be collected in these units. Such systems must be specially cleaned, rinsed and filled with treated water.



Inserts

The wire mesh and other inserts, such as ring, come in several variants. They may be arranged horizontally or vertically, come with or without a central core, and be shaped like a brush or a sieve. This improves their efficiency in relation to the empty pot but is not optimal and can be improved upon.



Helistill sludge separation process

This principle combines the previously explained principles while avoiding their disadvantages. Flow rate is reduced such that dirt is forced to sink. A multitude of inclined wings redirect the dirt downwards. The helicoid (downward spiral) arrangement allows even the smallest particles to settle in the central column. Due to the dirt particles colliding with the separator inserts, the speed reduction and the high density, the particles fall to the collecting area at the bottom of the separator, from which they can be removed.

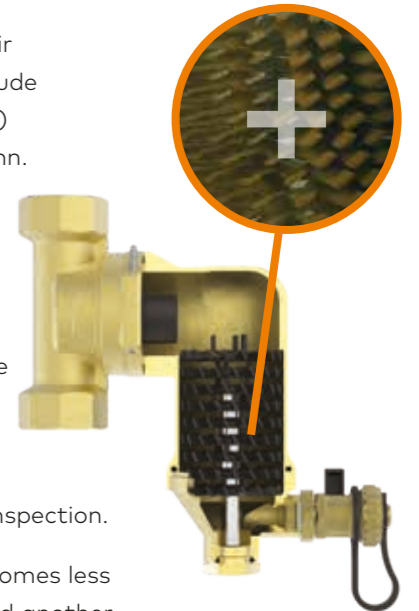

IMI Pneumatex Helistill separators combine the known principles of collision, speed reduction and density difference with a tangential flow dynamic in the collecting area by way of unique Helistill inserts. They have a multitude of wings that lead the sludge particles downwards. Without disturbance to the main flow, the sludge collects in the very large separation chamber. The pressure loss is low and constant. The removable bottom allows visual inspection.

This separation principle is optimal for slow and normal flow speeds but becomes less efficient at higher speeds in the pipe, for which IMI Pneumatex has developed another technology.

Cyclonic separation

Cyclonic separation is based on a variety of principles that guarantee its high separation efficiency:

- Centrifugal force – a cyclone creates rotation within the separator that directs even more force on the dirt particles. The combination of gravitational and centrifugal forces results in high efficiency.
- Depending on the speed inside the separator, the centrifugal force may be significantly more powerful than gravity.
- Because the water and dirt particles have different densities, the dirt particles end up being pushed to the outer wall of the separator.
- Downward stream – the downward movement created within the IMI Zeparo Cyclone/Zeparo G-Force separators guides the dirt particles to the bottom and into the dirt collection chamber.
- The cyclonic principle means the IMI Zeparo Cyclone/Zeparo G-Force separators can be mounted not only horizontally but at any angle below the horizontal, with only negligible differences in separation efficiency.

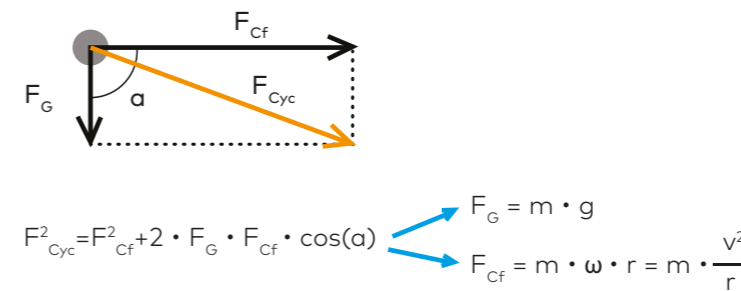

F_G = gravity force
 F_{Cf} = centrifugal force
 F_{Cyc} = cyclone Force
 m = mass
 g = gravity (9.81 m/s²)
 ω = angular speed
 v = speed
 r = reference radius

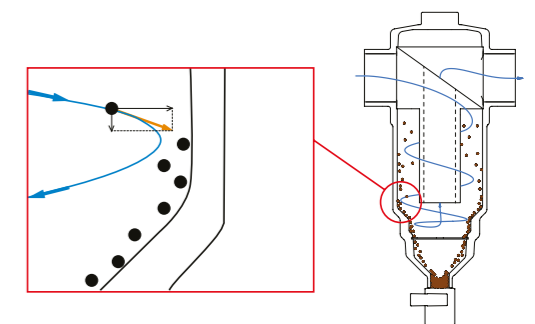

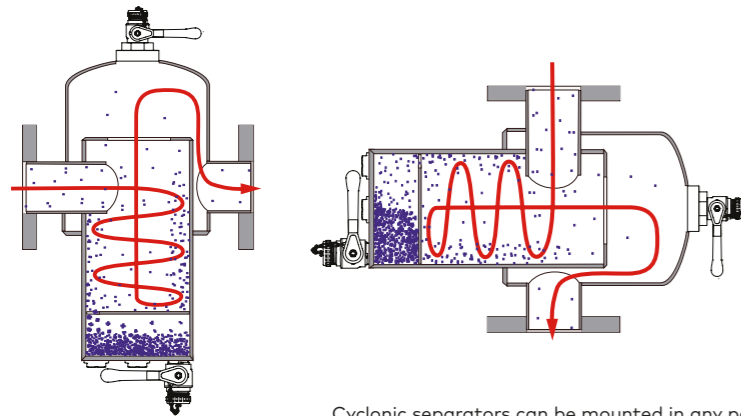
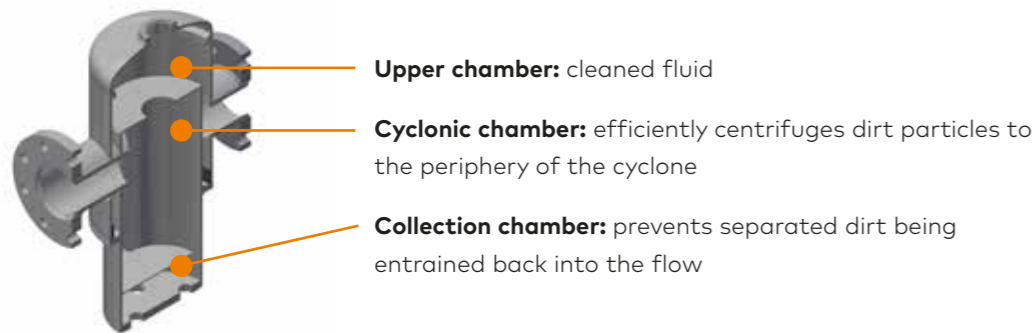

Cyclonic separators can be mounted in any position.



Magnetisation

Due to the small diameter and low weight of magnetite particles (< 5 m), they are very difficult to separate (low separation efficiency with standard separators) and the fine insert of a filter can be blocked quickly. Even cyclonic separators struggle to separate these small, light particles. As these particles can be magnetised, strong magnet rods offer the best means for removing them.



The magnet rod from the Zeparo can hold 143 g iron balls

Because magnetite particles are so small, it is imperative that that a magnet be of a size that allows it to completely enter the flow and that it have enough power. If not, it is possible that only a fraction of the magnetite will be "wrested" from the water flow. Finally, the magnet must be capable of maintaining its load over a long period of time, without exhibiting any ageing phenomena. IMI Pneumatex has long been known for using cadmium neodymium (CdNd) magnets, the most powerful and resistant on the market.

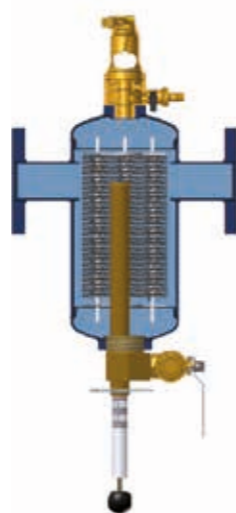

Difference in magnets used by competitors (on top of separator) and the Zeparo ZIO/G-Force

Pure magnetic separators

In systems with primarily magnetite-related problems, it can help to use pure magnetic separators with special high performance magnets.

Magnetic separators incorporate permanently installed high-performance magnets to trap magnetic debris (magnetite). They generally contain powerful rare earth magnets with high magnetic strength that can actively remove suspended magnetic particles from the system water. Magnetic separators may be fitted in line on the main system flow or in side stream bypass, depending on the filter design and pressure loss. Some designs are very effective at removing debris in a single pass, down to sub-micron particle size, which prevents the circulation of sludge in the system and its build-up in heat exchangers, pumps and radiators. As cleaning is dependent only on magnetic force, these separators can be mounted in any position. They are frequently installed on the return to the boiler, which is an ideal location. Magnetic separators should be checked at regular intervals, depending on the state and age of the system, but at least annually. It is recommended that Ferro-Cleaner be installed between two shut-off valves with the manual air vent.



Overview of the IMI Pneumatex Ferro-Cleaner portfolio and the size of the magnet

IMI Pneumatex Ferro-Cleaner filters the volume flow and uses a very strong magnet to remove the finest magnetite particles from the system water. The N 40 H Neodymium - Fe - Bor Magnet is one of the strongest permanent magnets on the market.

This prevents the particles from circulating further and damaging or destroying components such as boilers, pumps, valves, plate exchangers or underfloor heating. The maintenance process is simple and fast.



Inner view of a large version Ferro-Cleaner. Example of Ferro-Cleaner efficiency

Where diffusion leads to a plant having excessive oxygen content, the use of a magnesium sacrificial anode is recommended. The larger Ferro-Cleaner can accommodate both a magnet rod and this type of anode at the same time. In smaller sizes it can accommodate either a magnet or an anode.

Parameters influencing separation efficiency

Flow velocity

IMI Pneumatex separator with Helistill cartridge:

The lower the flow velocity in the separator body (the Helistill cartridge), the higher the separation efficiency.

Larger separators improve the efficiency.

IMI Pneumatex cyclone separator:

The higher the flow velocity at the separator, the better the cyclonic effect and the higher the separation efficiency. A minimum flow velocity must be satisfied to benefit from the cyclonic effect.

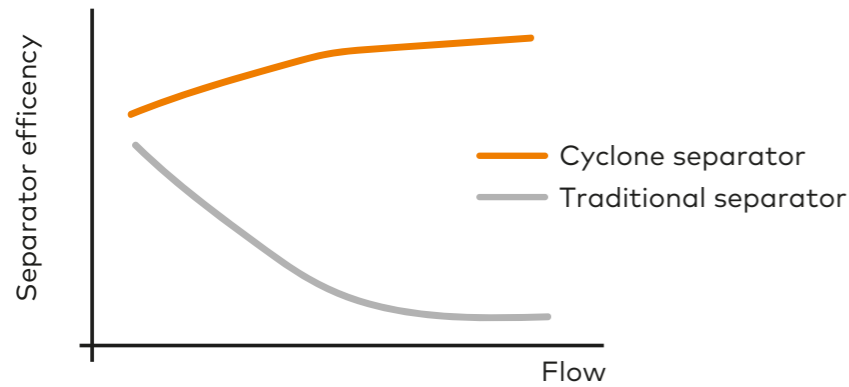

Particle diameter

Separation efficiency is greater when particle diameters are greater:

- Diameters below ~ 50 µm - lower separation efficiency without a magnet
- diameters above ~ 300 µm - separation efficiency is high, almost 100%

Difference in density

The difference in the density of the particles and fluid affects efficiency.

The greater the difference in their density, the greater the separation efficiency. Dirt/sludge separators cannot separate floating particles.

Particles smaller 100 µm are very hard to separate with normal separators. Magnets can help with the removal of these particles.

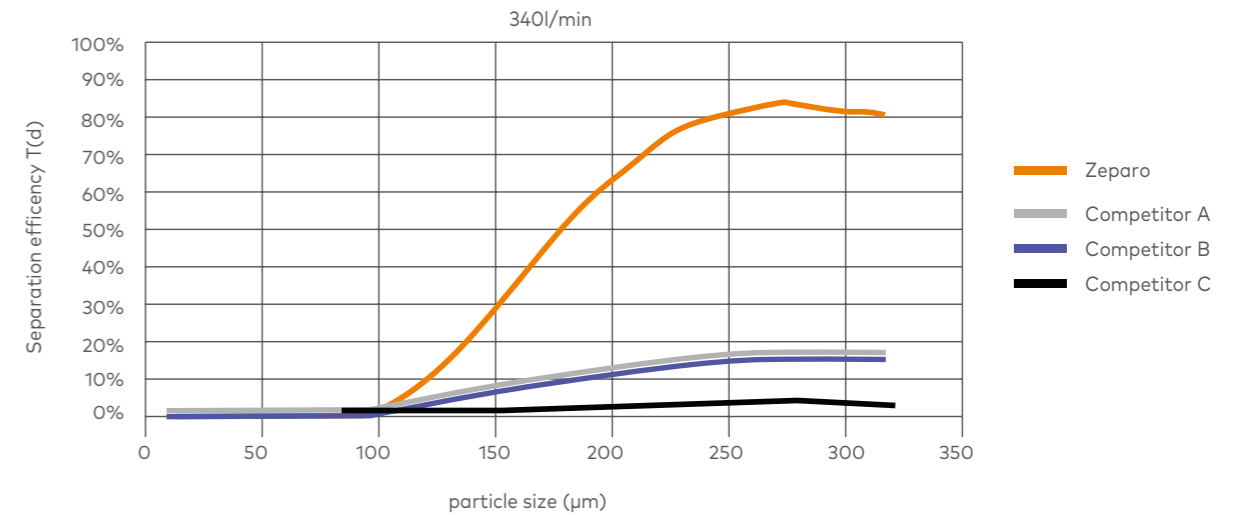

Typical separation efficiency as a function particle size in Zeparo cyclone separators compared to main competitors.

Importance of separation efficiency

Measured separation efficiency compared to competitors

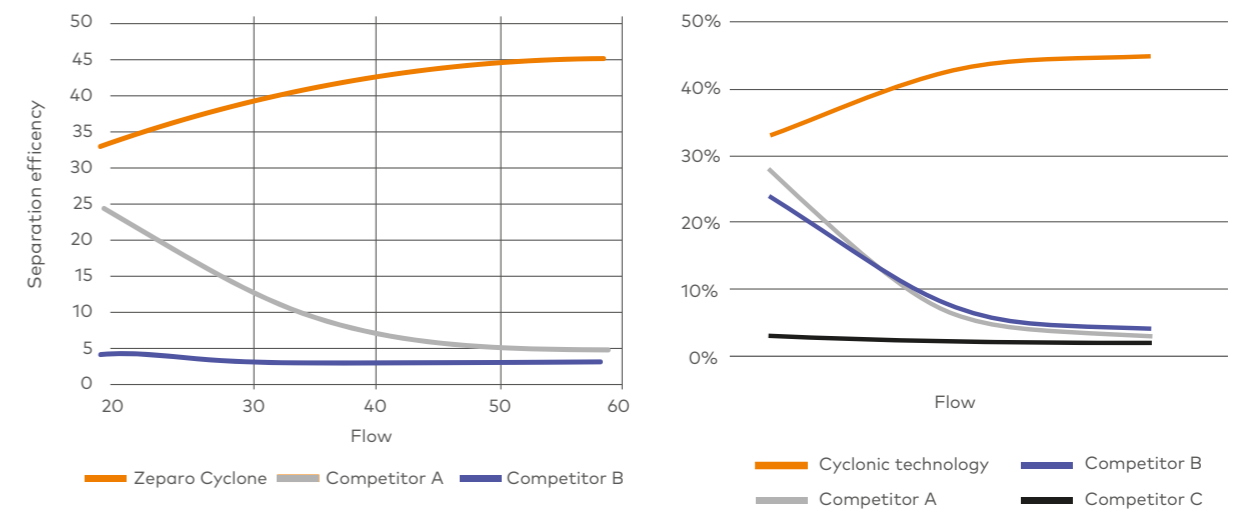

The cyclone separator has high separation efficiency and cleans your system in fewer cycles, each time reducing the quantity of dirt particles that would normally be deposited in your system with each additional cycle, which are very difficult to remove. The graph above is based on calculations that make the following assumptions:

Efficiency of Zeparo Cyclone: **40% / cycle**

Efficiency of a traditional dirt separator: **4% / cycle**

Accumulation rate in the installation: **3% / cycle**

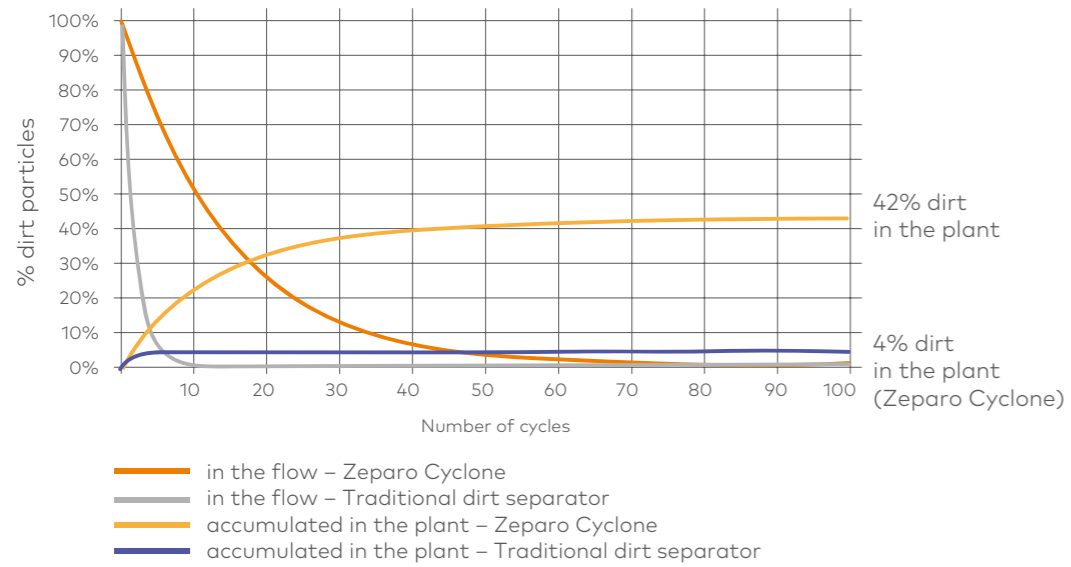

Sizing

Separators are sized by nominal flow rate.

The flow rate must not exceed the maximum flow rate for the chosen type or dimension.

Sizing is accomplished differently for different types of separators.

IMI Pneumatex's classic separators, such as the Zeparo ZU, ZIO and ZT, can be sized from 0 to nominal flow. The lower the velocity at the separator, the higher the separation efficiency.

	0%	30%	q_N	q_{Nmax}
Zeparo ZU	Green	Green	Green	Red
Zeparo ZT	Green	Green	Green	Red
Zeparo Cyclone G-Force	Red	Green	Green	Red
Ferro-Cleaner	Green	Green	Green	Red

Sizing areas of separators

IMI Pneumatex cyclonic separators such as the Zeparo Cyclone and the G-Force should be sized for the nominal flow. Efficiency is lowest at low flow rates. The higher the velocity at the separator, the higher the separation efficiency.

Select the separator where the nominal flow (q_N) is closest to the given design flow (q_D), then check if Δp is acceptable. Generally, cyclonic separators have bigger pressure losses than conventional methods. However, note the dP is high where the efficiency is the best and when it is the most critical: during the test and commissioning process of a new system operating at maximal flowrate. In contrast, during the operation of a variable flow system, pressure loss will also be significantly lower across cyclonic separators due to lower power demand.

Exact calculations can be obtained using HySelect or HyTools software, offered free of charge by IMI Hydronic for use with mobile devices.

System pressure

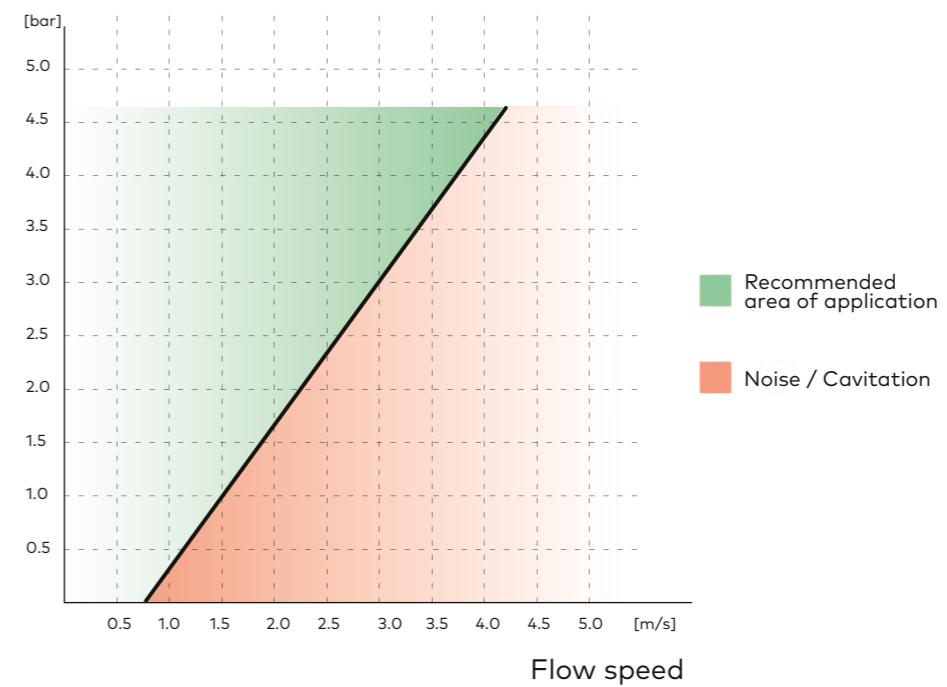

Minimum system pressure

Minimum system static pressure is required to avoid cavitation in the Zeparo G-Force.

Due to the inner diameter reduction, there is a potential risk of cavitation. To avoid this, the static pressure at the point where the Zeparo G-Force is installed must be equal to or greater than the value indicated in the normogram above.

As shown in the above graph, at a flow speed of 2 m/s a minimum static + dynamic pressure of 1.7 bar must be maintained at the inlet of the G-Force in order to avoid cavitation.

Application	Air separation			Dirt separation			Magnetite separation		Air and dirt separation					Vacuum degassing	
	Zeparo ZUV	Zeparo ZUVS	Zeparo ZTVI	Zeparo Cyclone	Zeparo ZUM	Zeparo ZTMI	Ferro-Cleaner	Zeparo ZUKM	Zeparo Turntable	Zeparo G-Force	Zeparo ZIO	Zeparo ZUCM	Vento	Simply Vento Vento Compact	
Products															
Model	Zeparo ZUV	Zeparo ZUVS	Zeparo ZTVI	Zeparo Cyclone	Zeparo ZUM	Zeparo ZTMI	Ferro-Cleaner	Zeparo ZUKM	Zeparo Turntable	Zeparo G-Force	Zeparo ZIO	Zeparo ZUCM	Vento	Simply Vento Vento Compact	
SYSTEM APPLICATION															
Heating systems	✓	✓	✓	✓	✓	✓	✓	✓	✓	✓	✓	✓	✓	✓	✓
Cooling systems	✓	✓	✓	✓	✓	✓	✓	✓	✓	✓	✓	✓	✓	✓	✓
Solar systems		✓													
TECHNOLOGIES USED															
Helistill	✓				✓			✓				✓			
Cyclone				✓						✓			✓		
360° rotation			✓						✓						
AVAILABLE ACCESSORIES															
Magnet				optional	✓	✓	✓	✓	✓	optional	optional	✓			
Insulation			✓	optional	optional	✓		optional	✓	optional	optional	optional	optional		
Insulation with magnet				optional											
PRESSURE															
	PN 10	PN 10	PN 10	PN 10	PN 10	PN 10	PN 10/16	PN 10	PN 10	PN 16/25	PN 10	PN 10	PN 10	PN 10	PN 10

Overview in the IMI Pneumatex Separator portfolio

✓ Magnet included



Installation in Practice

Installation position of dirt separator

Dirt and sludge separators should be installed before the heat generator or chiller/heat pump. This better protects the unit from dirt deposits. This placement is independent of unit type.

Dirt separators should be installed upstream of the pump and contain a magnet to avoid magnetite being deposited mostly in the pump housing.

The same is true for heat meters. A dirt separator with a magnet protects the water meter inside the heat meter from dirt deposits.

IMI Pneumatex Zeparo ZU and ZIO separator with Helistill insert

This separator can be installed in only one position, with the rotation axis of the Helistill insert perpendicular to the ground.

IMI Pneumatex Zeparo ZT separator with Helistill insert

The separator's connection piece can be installed in any position, while the separator housing with Helistill insert must be vertical. It can be installed in any position, but the rotation axis of the Helistill insert must be perpendicular to the ground.

IMI Pneumatex Zeparo Cyclone separator

One of the main advantages of Cyclone separators is that they can be installed in any vertical or horizontal position.

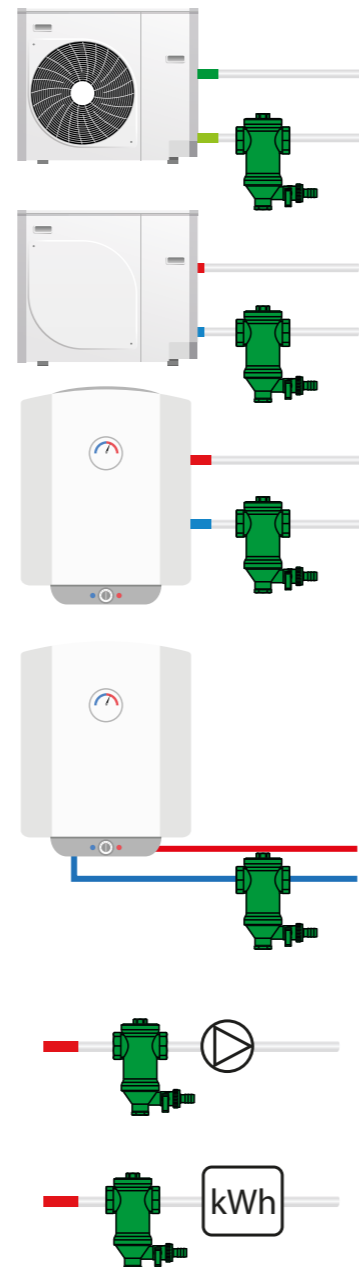

Different types of hydronic systems

The following circuits illustrate the preferred solutions. Alternatives are possible provided that the HB limit values are maintained.

HB = static height required for microbubble separation at maximum system temperature upstream of the separator

tmax °C	90	80	70	60	50	40	30	20	10
HB mWs	15.0	13.4	11.7	10.0	8.4	6.7	5.0	3.3	1.7

Wall-hanging gas boiler

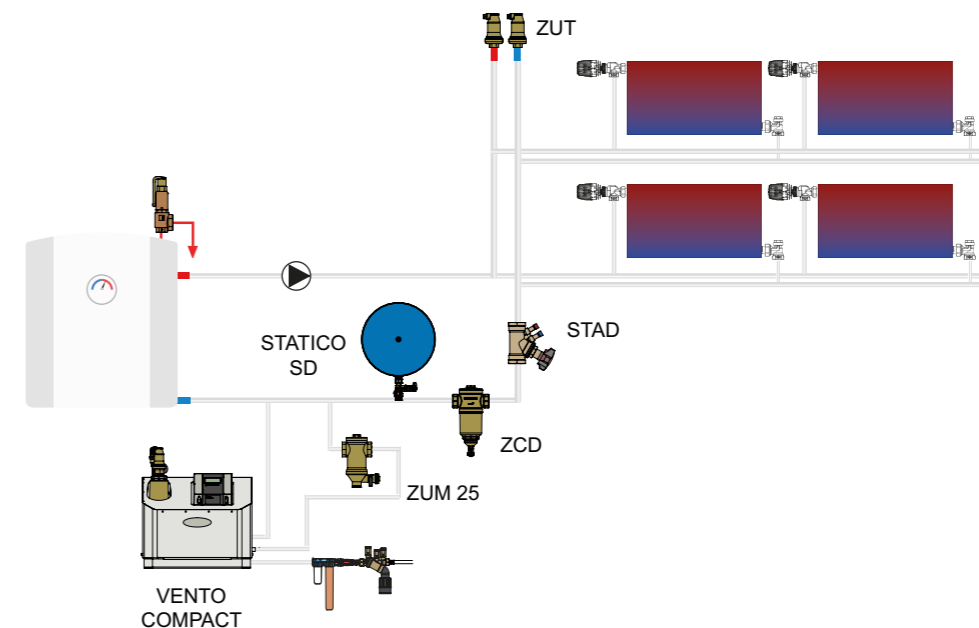
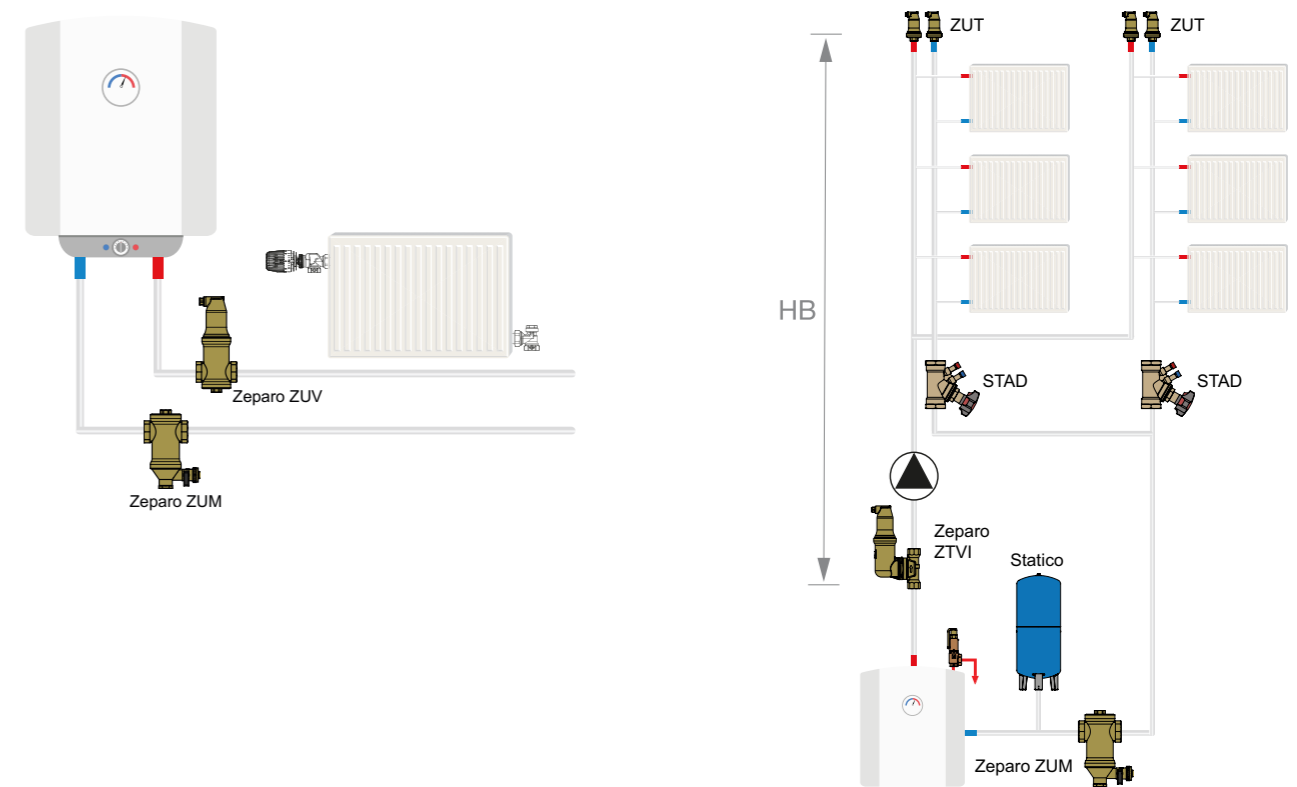

Radiator system with Statico fixed gas cushion expansion vessel
Statico and vertical distribution

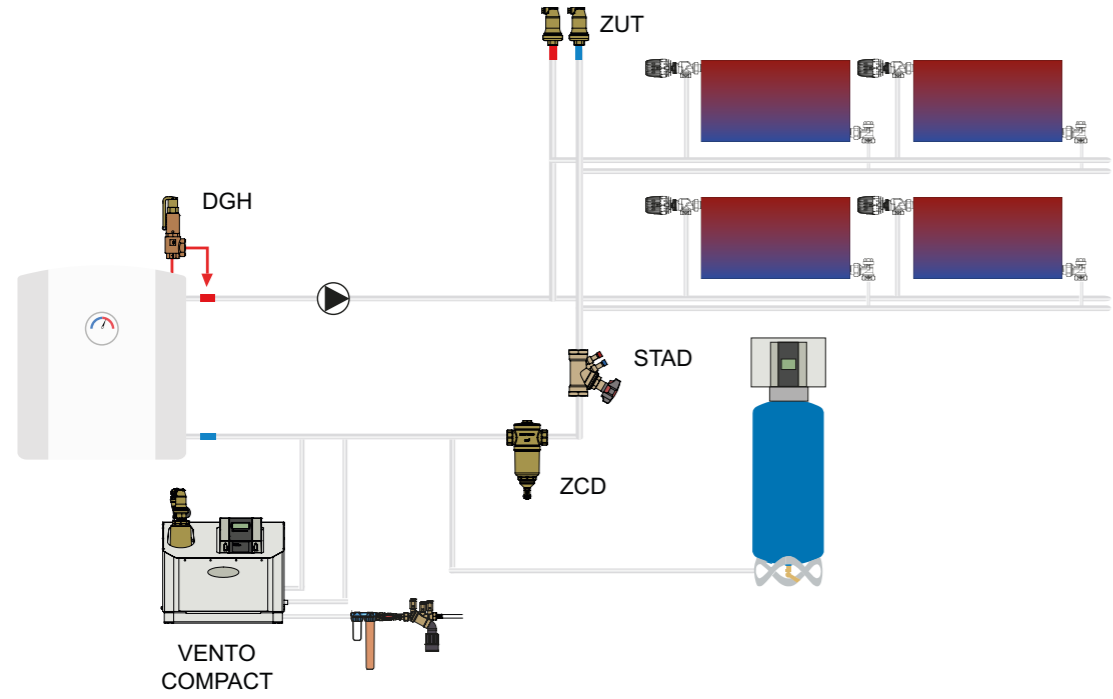

Small heat pump system with surface heating and air separator

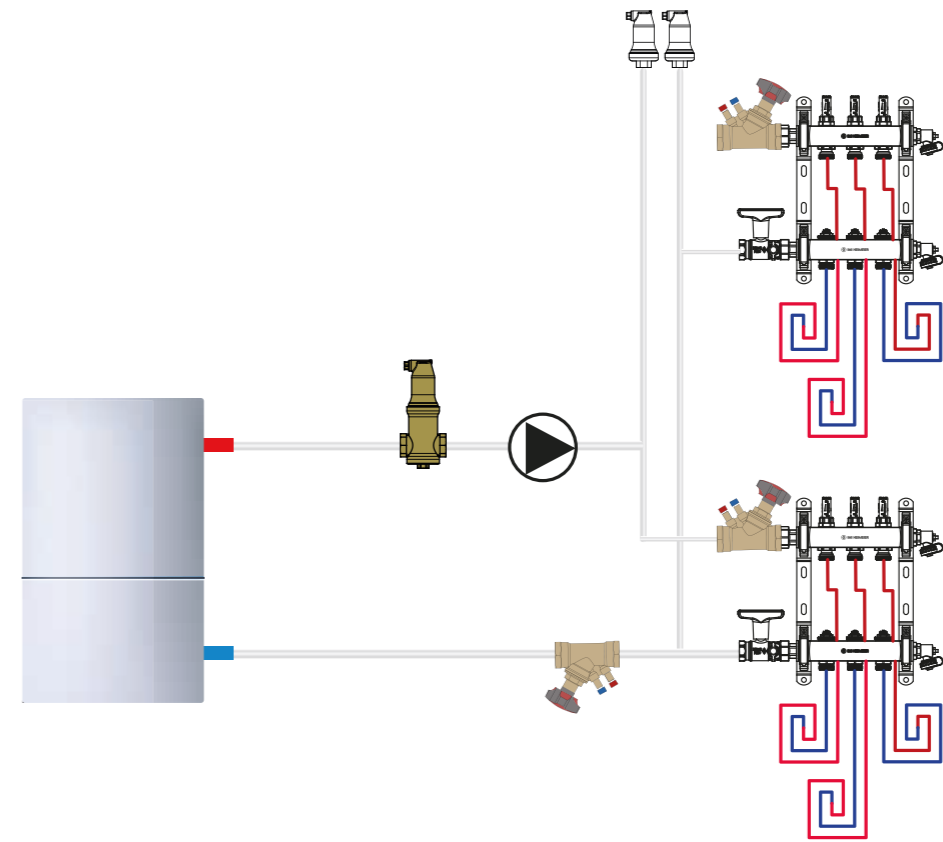

Solar system for lower temperatures

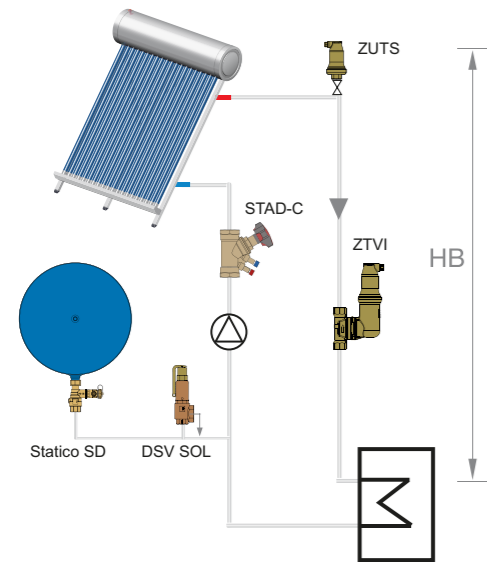

Solar system for higher temperatures and intermediate vessel DD

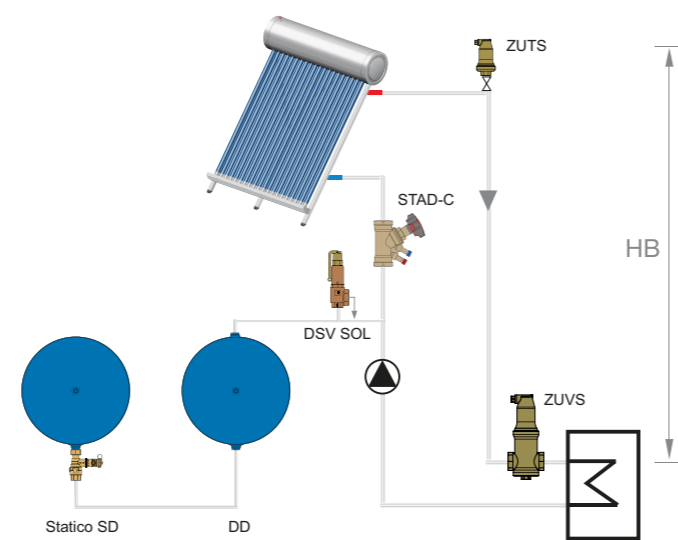

Larger Vento heat pump system with surface heating and vacuum degasser

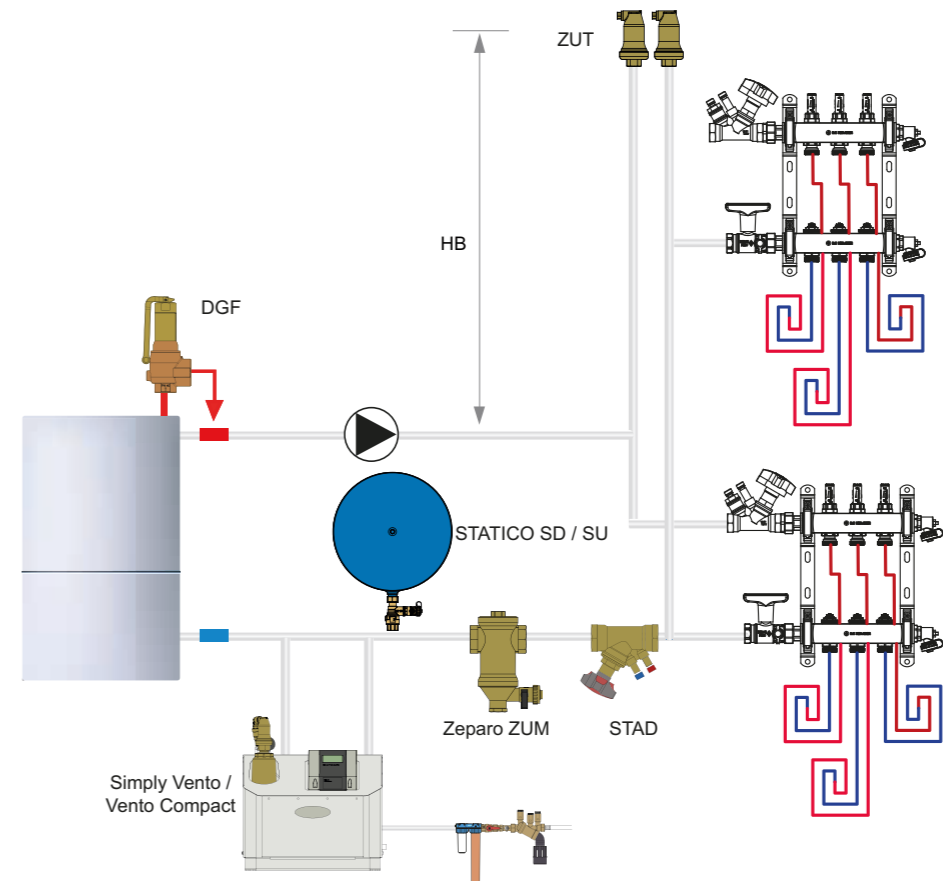

Large heating system

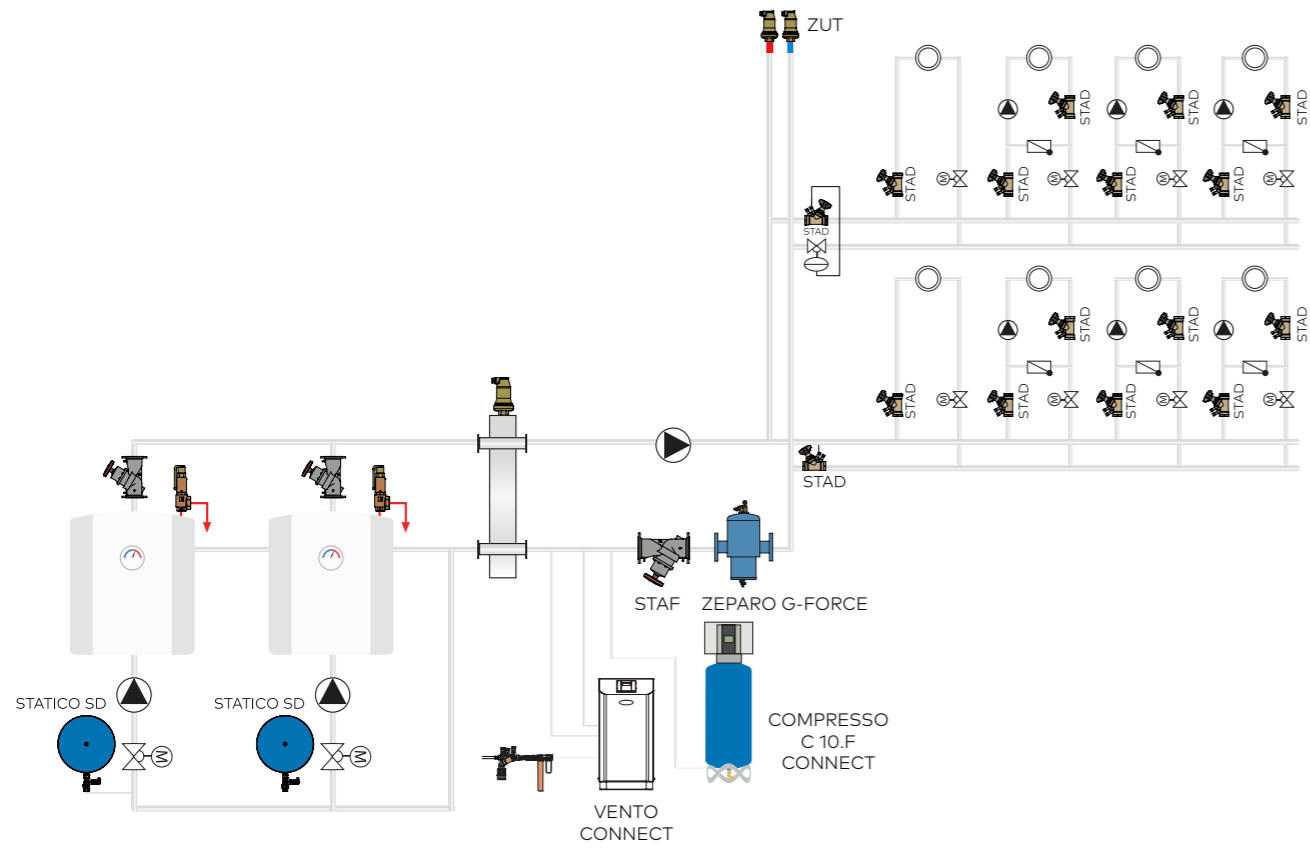

District heating – heat exchanger

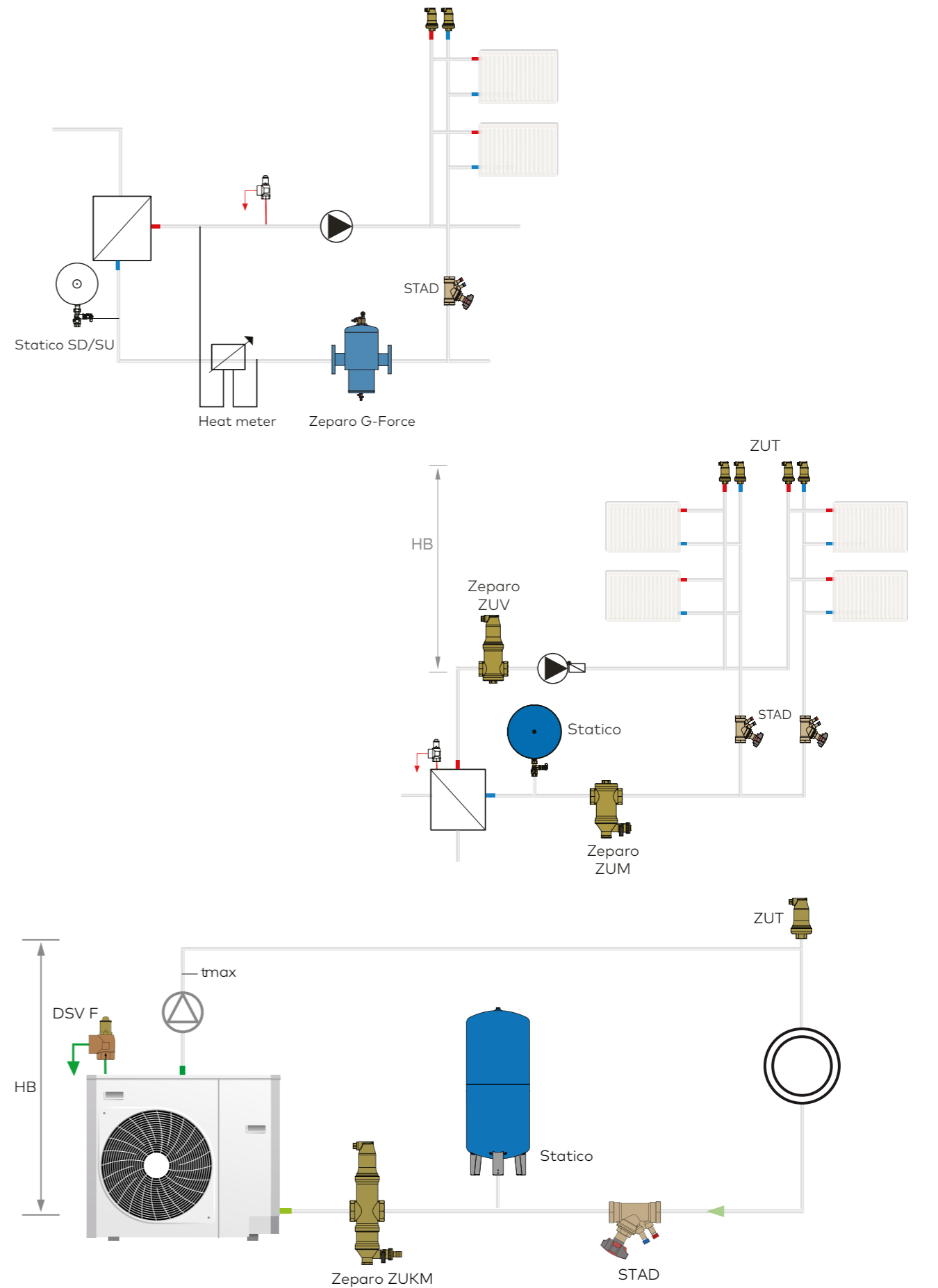

Low loss header with variable flows on the primary and secondary sides

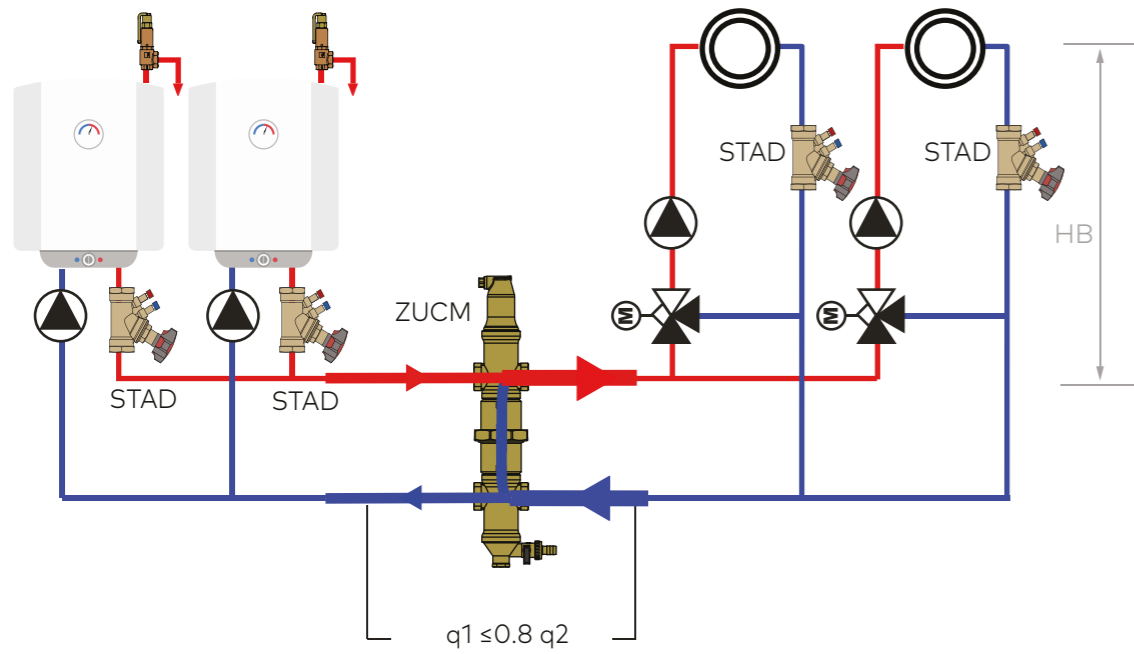

Cooling systems with chiller

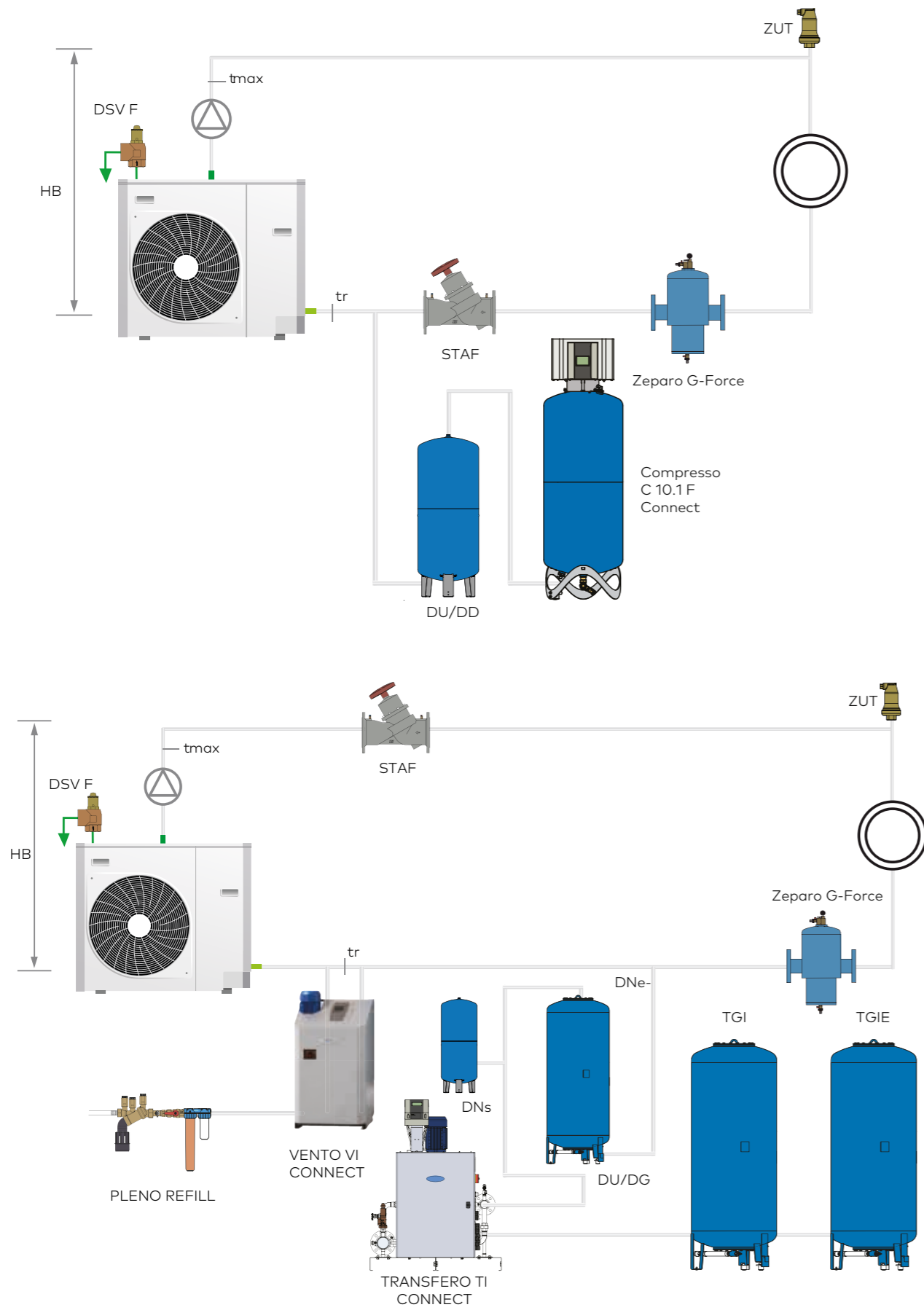

Heating/cooling system with a Transero dynamic pressurisation system and integrated vacuum degassing, which works for both heating and cooling. Automatic water content management

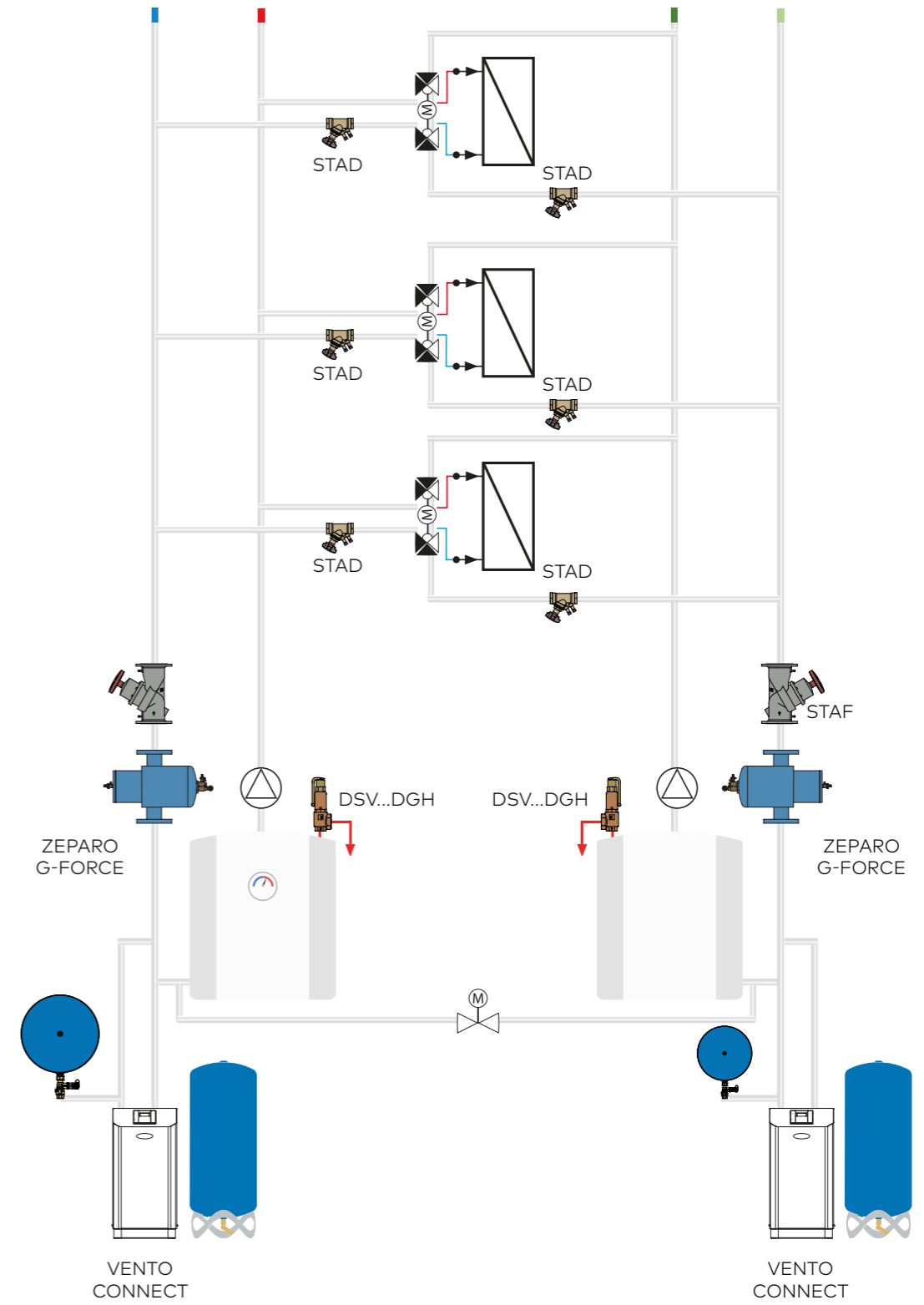

Rules for air and dirt/sludge prevention

- Correct dimensioning of the expansion system
- Permanent separation of different gases
- Regular maintenance and monitoring of the expansion system
- Repetitive control of water quality and dirt separators
- Water make-up quantity monitoring.

Closed hydronic systems

Prevention is the most effective form of protection

- The "air supply" through make-up water must be minimised. Systems must not leak.
- The "air supply" through the atmosphere must be prevented. That means sufficient overpressure at all points and at all times in the system. The elastomers in the system components should be of the right quality.
- Reliable, totally closed pressure maintenance and system technology are a must!
- The inevitable gas build-up in the system must be vented off to the outside in a targeted and safe manner.

Blow-down period in the dirt/sludge separator

Due to the operation principle of the dirt/sludge separator, the quantity of dirt particles collected at the high Dp of the strainer is not clearly signalled; hence there are no standards for the blow-down period of dirt/sludge separators.

Draining periods in practice:

- New clean installation: depending on the quantity of separated particles, it may be possible to identify blow-down frequency a week or two after the first blow-down.
- Retrofit of old systems or new installation with significant dirt: a few hours after start-up and to examine the drained fluid, depending on the quantity of separated particles, but some weeks the separator may need to be drained every day.

Please always examine the quality of the drained fluid. When the fluid starts looking cleaner with each blow-down, you can reduce blow-down frequency to 4 to 6 times per year.

Due to the great efficiency of the cyclonic separators, the first blow-down cycles are shorter than for a conventional separator.

Please note that every hydronic system is different!

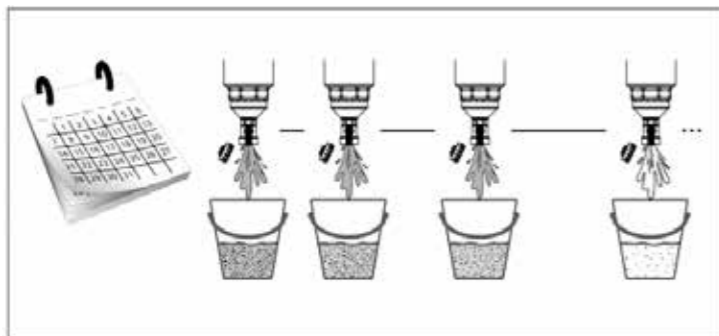

IMI Pneumatex Solutions

Air separation

Automatic air vent

Zeparo ZUT / ZUP air vents – to remove free air when filling the system

Type		Dimension	PN	Feature
ZUT		15 20 25	10	
ZUTS		15	10	Solar systems up to 160 °C
ZUP		10	6	
ZUPN		10 15	6	Nickel-plated
ZUTX		25	10	Lockable External thread

- Safe, dry discharge of separated gases
- Stable float handling in a large, flow-balanced chamber. Dirt and water are kept away from the precision valve, also at high pressures
- Emergency screw plug with signal function just in case, in the unlikely event that it starts to leak
- No damaging leakage, no calcium deposit
- No operation and replacement costs from a leaking automatic air vent
- Reliable high capacity even at high pressures

Large gap of 40 mm between the float (water level) and the shut-off valve. This prevents contamination or calcification of the valve, as the spray mist when the air bubbles break through the surface tension of the water level has no negative influence. Otherwise, the spray mist would deposit calcium on the valve when it dries, which would lead to leaks.

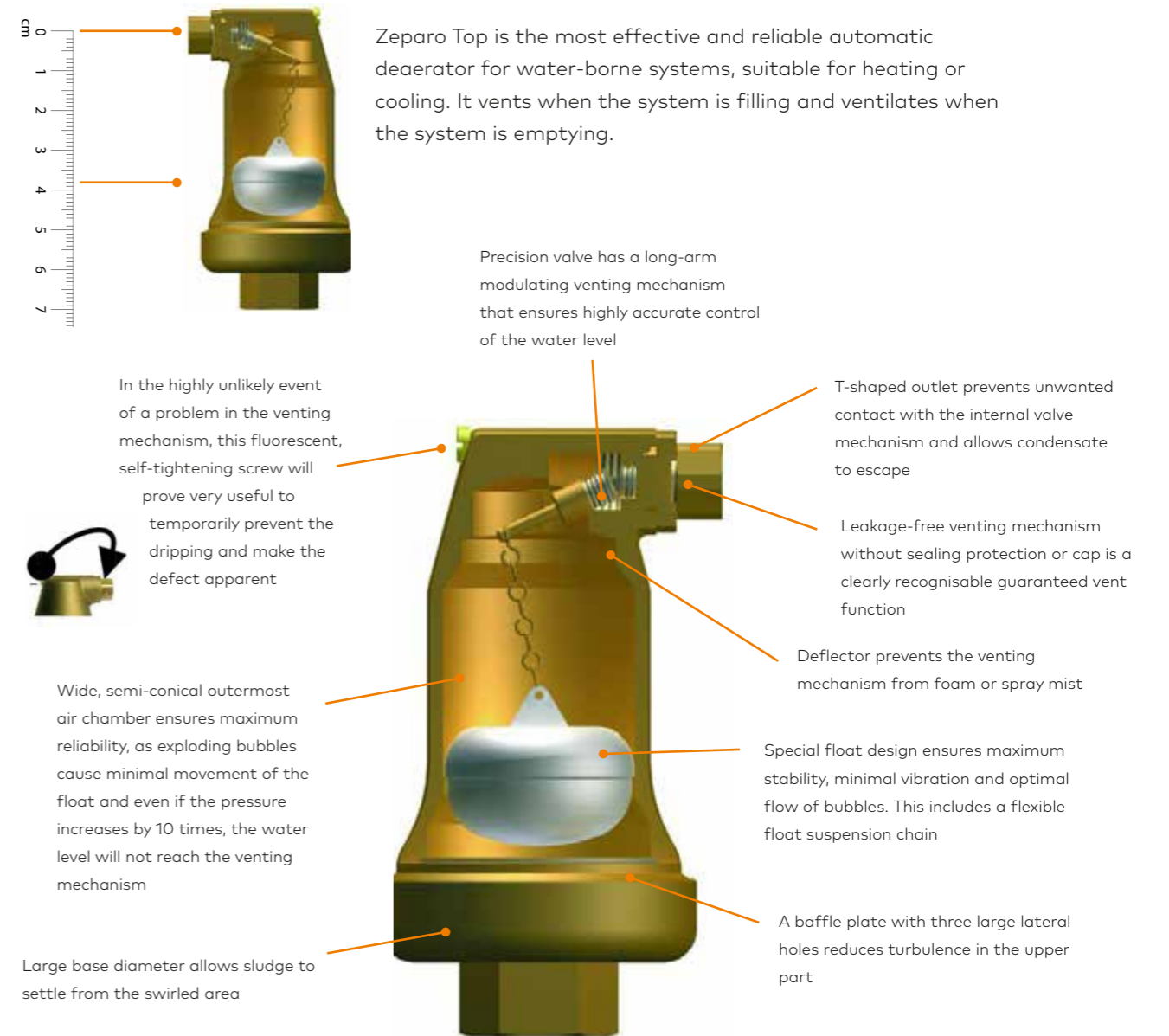

Widest possible insertion diameter reduces the risk of capillary constipation due to a stagnant bladder (3/8" is a compromise, minimum 1/2" is recommended)

Microbubble separation

Type		Dimension	PN	Material	Feature
ZUV		20 25 32 40	10	Brass	Helistill separator
ZUVS		20 25 32 40	10	Brass	Solar systems up to 160 °C Helistill separator stainless steel
ZTV		20 22* 25 32	10	Brass	Turnable 360° Mounts in any position Helistill separator
ZIO		50 65 80 100 125 150 200 250 300	10 16	Steel flanges	Helistill separator

* For 22 mm pipes with additional KOMBI compression couplings



Zeparo ZUV/ZIO microbubble separators

Separators for lower flow rates and variable flow. High efficiency due to the Helistill separator inside. With baffles arranged in an upward helix, the separator utilises an optimal combination of separation principles

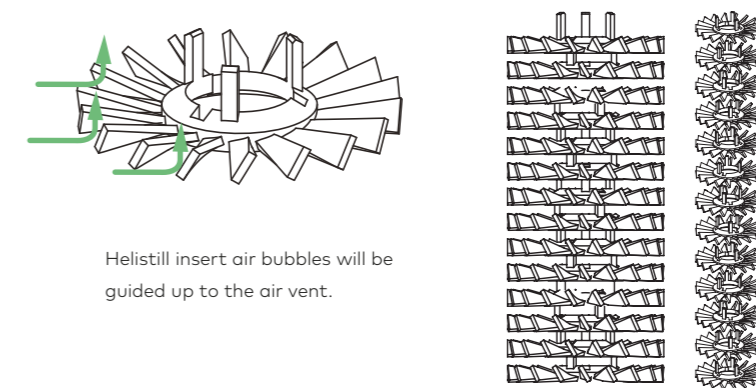

Vacuum degassing

Vento Compact / Simply Vento

Simply Vento is a cyclonic vacuum degasser for heating systems. By rotating the water in a special cyclonic vacuum vessel, the gases are separated from the water completely. Its use is particularly recommended where performance, compact design and precision are required. The BrainCube Connect control panel allows a new level of connectivity, enabling communication with the BMS system and other BrainCubes, as well as remote operation of the pressurisation system through live viewing.

System pressure up to 2.5 bar.



Vento Connect

Vento Connect is a cyclonic vacuum degasser for heating systems, solar systems and chilled water systems. Its use is particularly recommended where high performance, compact design and precision are required. The industrial version VI is especially designed for high pressure applications up to 20.5 bar. The BrainCube Connect control panel allows a new level of connectivity, enabling communication with the BMS system and other BrainCubes, as well as remote operation of the pressurisation system through live viewing.



TecBox control unit

- BrainCube Connect control for intelligent, fully automatic and safe system operation. Self-optimising with memory function
- Resistive 3.5" TFT illuminated colour touch display. Web-based interface with remote control and live view. User-friendly, operation-orientated menu layout with slide and tap operation, step-by-step start-up procedure guide and direct help in popup windows. Representation of all relevant parameters and operation status in plain text, graphically and/or multilingually
- Standardised integrated connections (Ethernet, RS 485) to the IMI webserver and BMS (Modbus and IMI Pneumatex protocol)
- Software updates and data logging possible via USB connection - data logging and system analysis, chronological message memory with prioritisation, remotely controllable with live view
- Periodic automatic self-test, daily check of the vacuum. BrainCube Connect generates an alarm if necessary
- High quality metal cover

FillSafe

FillSafe offers direct vacuum degassing and monitoring of water make-up.

The BrainCube Connect control system uses an integrated contact water meter and solenoid valve to monitor the quantity of make-up water and the duration and frequency of its replenishment and sounds an alarm if the limit values are exceeded. BrainCube also controls the capacity of the water treatment device and sounds an alarm when capacity is reached.

If there is risk of leakage in the plant, this warning can be reported to a BMS system or via the Internet.

Easy commissioning

Remote access and support are offered for troubleshooting, as well as automatic calibration and built-in interfaces for communication with the IMI web server and the building management system.

A version is available for cold water systems.

All devices can also be supplied with a condensation-insulated version for cold water systems.

Transfero TV / TVI Connect

This is the only pressurisation unit on the market with integrated cyclonic vacuum degassing.

Transfero TV Connect is a precision pressure maintenance device for heating and solar systems up to 8 MW and chilled water systems up to 13 MW. Its use is particularly recommended where high performance, compact design and precision are required. The new BrainCube Connect control panel allows a new level of connectivity, enabling communication with the BMS system and other BrainCubes, as well as remote operation of the pressurisation system through live viewing.

This offers the same performance as the Vento variants but with additional pressurisation functionality.

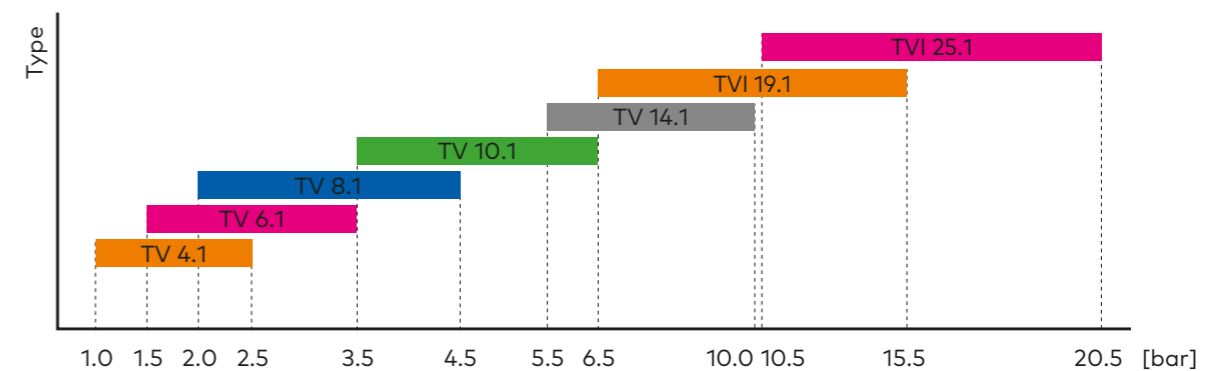

Operation range (dpu) for Pneumatex Transfero pressurisation and vacuum degassing units

Dirt/sludge Separation

Dirt and sludge separators with and without magnet

Type		Dimension	PN	Material	Feature	Magnet					
ZCD		20	10	Brass	Cyclonic separation system	 optional					
		25									
		32									
		40									
		50									
ZCDM		20	10	Brass	Cyclonic separation system	 yes					
		25									
		32									
		40									
		50									
ZUD		20	10	Brass	Helistill separator						
		25									
		32									
		40									
ZUM		20	10	Brass	Helistill separator	 yes					
		25									
		32									
		40									
ZTM		20	10	Brass	Turnable 360° Mount in any position	 yes					
		22*									
		25									
		32									
G-Force		65	16	Steel flanges welding ends	Cyclonic separation system	 optional					
		80									
		100									
		125									
		ZIO					150	10	Steel flanges		 optional
							200				
							250				
							300				

* For 22 mm pipes with additional KOMBI compression couplings

Zeparo Cyclone / G-Force dirt separators with cyclonic technology

The high level of separation efficiency of cyclonic technology means your system is cleaned in fewer cycles, reducing the quantity of dirt particles that would normally be deposited in the system with each additional cycle. The dirt collected can be flushed out easily and quickly with the help of the drain valve.

The high efficiency is independent of dimension. Dirt separator's efficiency increases as flow velocity increases. The pressure drop remains stable during operation regardless of how much dirt is collected. In higher flows (e.g. cooling applications) there is even more protection.

The magnet accessory optimises separation efficiency even more for sludge and magnetite (black iron oxide) deposits consisting of finer magnetic particles. Easy handling and cleaning. Combines magnetic separation and thermal insulation. Can be ordered as a set with Zeparo Cyclone or separately as an accessory.

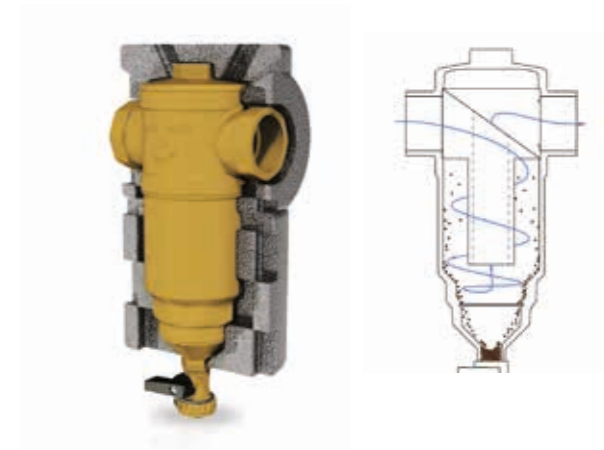

Zeparo ZUD / ZUM, ZTD / ZTM turnable, Dirt version for sludge particles

Separators for lower flow rates and temporary flows. High efficiency due to the Helistill separator inside.



Helistil separator

Optimal combination of all known separation principles

With baffles arranged in an upward helix, the separator employs an optimal combination of separation principles:

- Reduced flow speed
- Baffle
- Centrifugal effect

Zeparo ZUM is the most effective and reliable automatic dirt and sludge separator for water-carrying systems, suitable for heating or cooling. It cleans while the system is operating and reliably separates dirt and sludge.

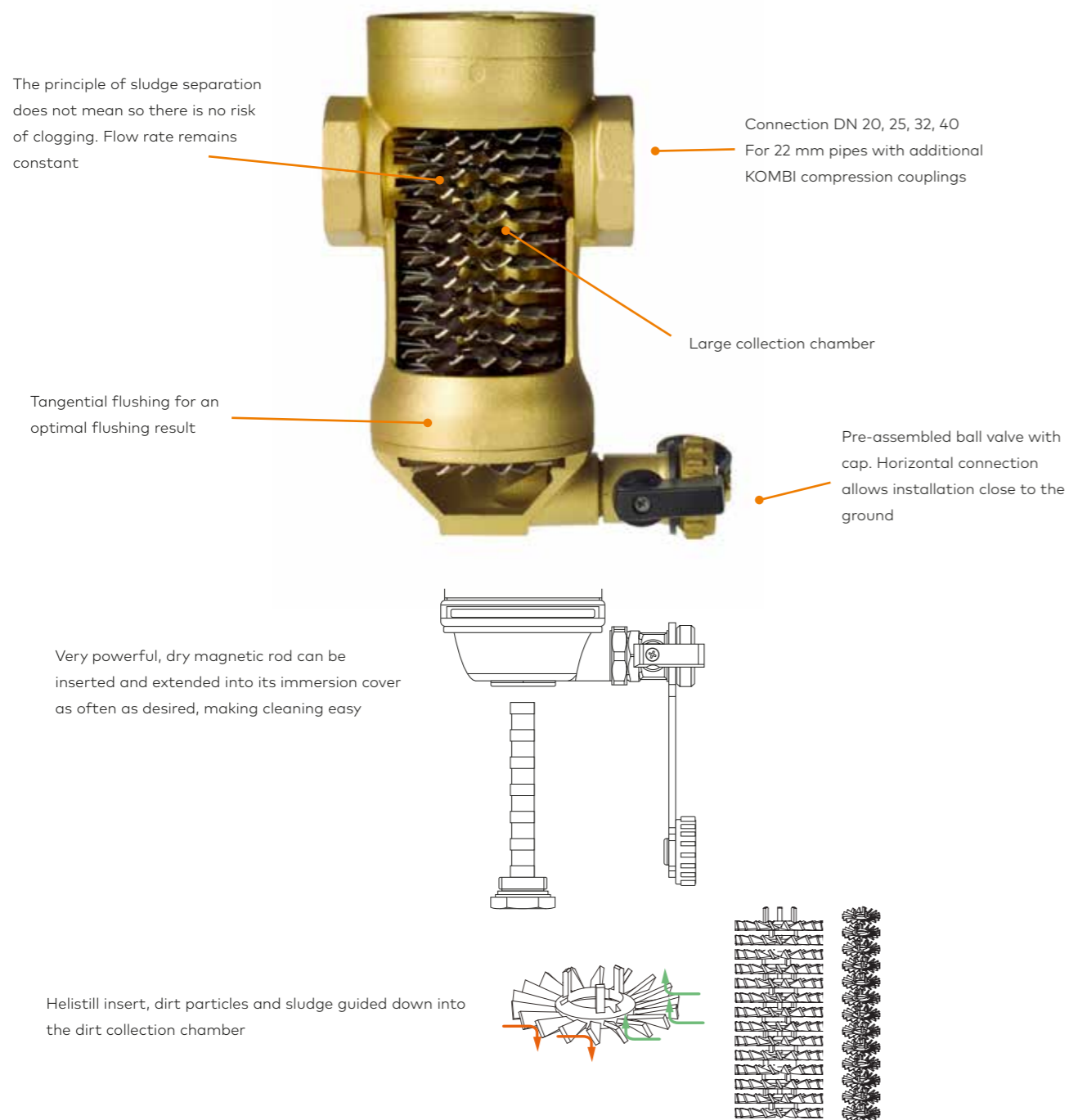

No clogging as with filters and low constant pressure loss, independent of the volume of separated sludge

- Excellent particle separation performance
- Easy to clean, without system interruption
- Installation in the main line to protect valuable plant components such as boilers and pumps from sludge deposition
- To flush out sludge, simply pull out the magnetic rod and open the valve

Pure magnetic separators



Type		Dimension	PN	Material	Feature	Magnet
Type 80		32	16	Brass	Oxygen-reducing anode on request	 yes
Type 150		65 80 100	10	Bronze	Oxygen-reducing anode on request	 yes
Types 273 323 406 606		125 150 200 250 300 400 500	10	Stainless steel	With magnet and anode	 yes

Ferro-Cleaner

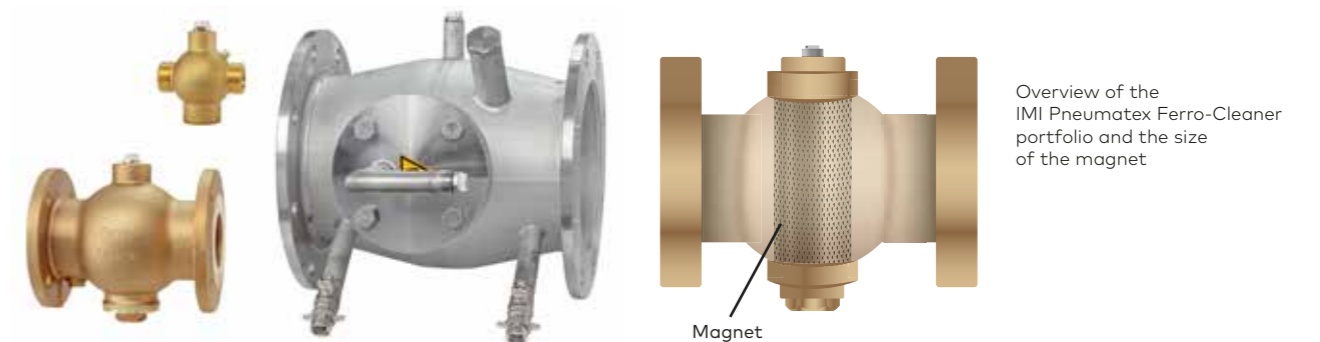
Ferro-Cleaner magnetic flux filter system protects heating and cooling systems against sludge and corrosion. It is simple, practical, effective and safe to install, operate and maintain. Vertical or horizontal, Ferro Cleaner can be installed in any position without performance loss. Its compact design simplifies installation and effective use. Installing it will have a positive effect on the performance and service life of the system. A sacrificial anode can be used instead or DN 125 and above in addition to the magnetic rod.



Combined air and dirt separators

Type		Dimension	PN	Material	Feature	Magnet
ZUKM		20 25 32 40	10	Brass	Combined air and dirt separation Two Helistill separators	 yes
ZTKM		20 22* 25 32	10	Brass	Turnable 360° Mounts in any position Two Helistill separators	 yes
ZUCM		20 25 32 40	10	Brass	Combined air and dirt separation Low loss header between production and distribution side of hydronic Two Helistill separators	 yes

* For 22 mm pipes with additional KOMBI compression couplings



Zeparo ZUKM

Separator, Kombi version for microbubbles and sludge particles with magnet. Ideal for cooling systems

Zeparo ZTKM

Separator, Kombi version for microbubbles and sludge particles with magnet. The separation chamber can be rotated 360 degrees, allowing the Zeparo ZT to be mounted in different position

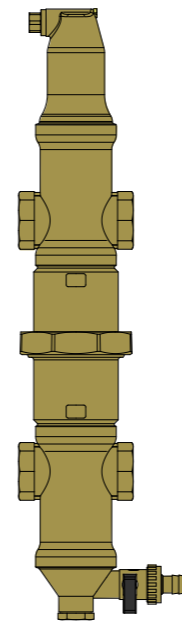

Zeparo ZUCM

Low loss header, Collect version with magnet for microbubbles and sludge particles.
Combination air and dirt separator with low loss header for hydronic and air and dirt problems in the system

Low loss header with variable flows on the primary and secondary sides

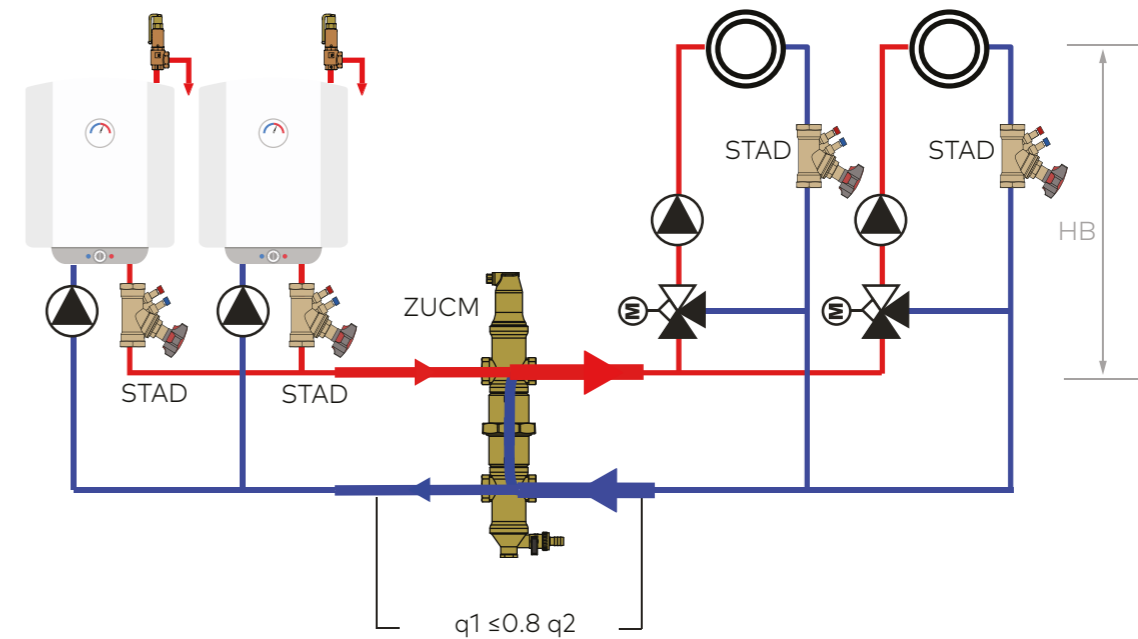

ZUCM	q_1 [m ³ /h]
20	≤ 1.25
25	≤ 2
32	≤ 3.7
40	≤ 5

APPENDIX A

From THE HYDRONIC ENERGY EFFICIENCY FACTBOOK

Fact no. 11

Corrosion and dirt deposits in pipes can increase the electrical pumping costs of a heating or cooling system by as much as 35% (*) in its initial years of operation.

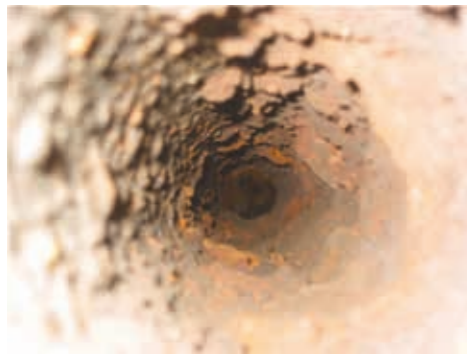

Pipe pressure drops (often called linear pressure drops) are contingent upon:

- the internal diameter of the pipe
- pipe roughness
- water (heat transfer fluid) density and viscosity
- flow
- the presence of oxygen as a result of inadequate or incorrectly maintained pressure devices causing corrosion
- dirt deposits (due to bad water quality and insufficient water flow velocity in some parts of the plant) consistently altering roughness by 15% to 70% during the first years and 150% to 240% (**) after 20 to 50 years. To compensate for this increase in pressure drop, the pump head needs to be increased by the same amount, causing electrical pump consumption to increase

Example:

Pipe DN 25 from Steel DIN 2440, ISO 65 series

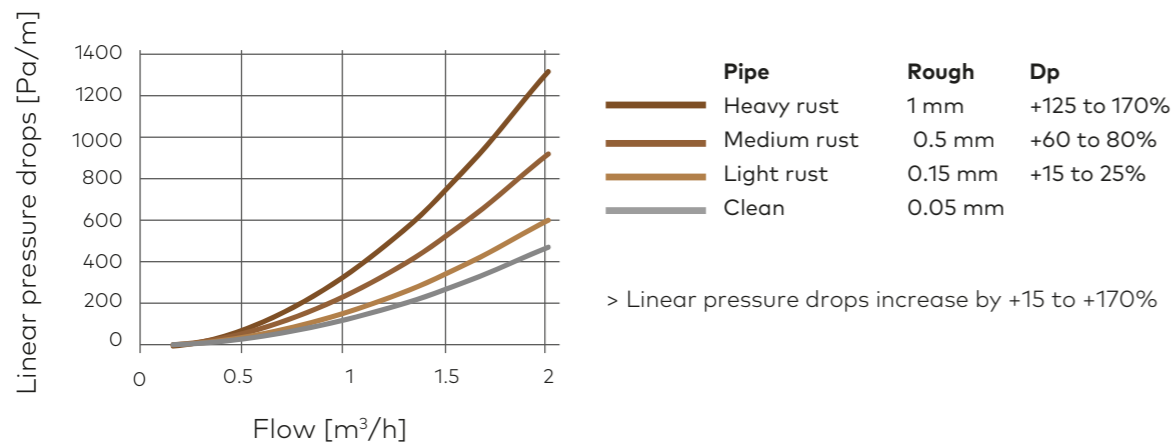

(*) If a pipe pressure drop represents 50% of the total pressure drop of the system, a 70% increase in pipe pressure drop will have a direct 35% impact on electrical pipe consumption to achieve the same flow. (**) Source: Result published by Utah State University, Pr Rahmaye.

Fact no. 18

Air build-up in radiators can dramatically reduce a unit's power output by as much as 80%.

The presence of air in the water must be minimised, not only to reduce corrosion and noise but also because its presence reduces emissions from terminal units.

The thermal picture (see picture example) shows that the creation of air pockets prevents water circulation in the radiator and dramatically affects load output.

To compensate for the discomfort of lower radiator emissions, users raise the outlet temperature on the boiler and the pump velocity. This has a significant impact on a heating system's energy consumption (see facts no. 4, no. 8 and no. 12))(**).

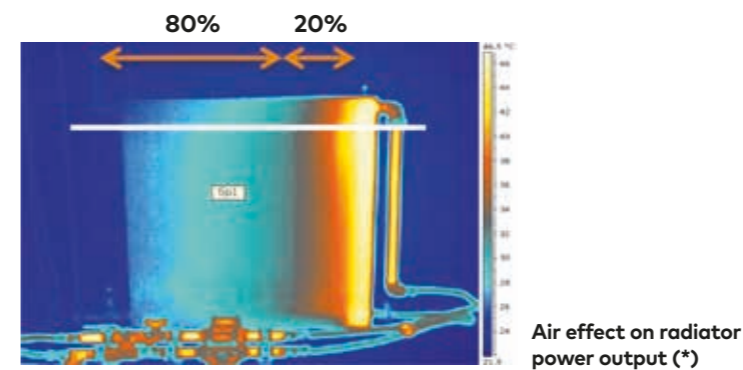

(*) Thermal measurement from Institute "Karel de Grote Hoger School"

(**) For more energy facts please consult IMI Hydronic Engineering Energy Facts 2021.

Units of measurement

- Unless otherwise stated, pressure measurements always refer to gauge pressure.
- Gas content in water stated in ml/l relates to the standard state of 0 °C, 0 bar.
- Nitrogen N₂: 1ml/l = 1.25046 mg/l
- Oxygen O₂: 1ml/l = 1.42895 mg/l

Terms

When we speak of a vacuum in connection with degassers, we do not mean a physical vacuum (or any absence of matter) but a negative pressure range between local atmospheric pressure and the saturation pressure of the medium.

Sources

- [1] "Gase in kleinen und mittleren Wasserheiznetzen" Technische Universität Dresden, Institut für Energietechnik, koordinierter Schlussbericht, AiF Forschungsthema Nr. 11103 B, November 1998
- [2] "Vermeidung von Schaden in Warmwasser-Heizungsanlagen - Steinbildung und wasserseitige Korrosion" VDI 2035 Bl. 1, März 2021
- [3] Rühling, K. "Test von Entgasern in Technikums-Kreisläufen mit Wasser" Technische Universität Dresden, Professur für Gebäudeenergie-technik und Wärmeversorgung im Auftrag der IMI Hydronic Engineering Switzerland AG, November 2017 und Januar 2018
- [4] Koch, F.; Rühling, K.; Heymann, M. "Test von Entgasern in Technikums-Kreisläufen mit Wasser-Ethylenglykol-Gemisch" Technische Universität Dresden, Professur für Gebäudeenergie-technik und Wärmeversorgung, Februar 2022



Air & Dirt: Problems, Causes, Technology

How do air and other gases get into heating and cooling systems? What are the most effective remedies? What creates magnetic sludge? How do you avoid this phenomenon and how do you get rid of the dirt?

This technical guide answers these questions and many others about the air and dirt in these systems. IMI Hydronic Engineering has the most complete range available of automatic air vents, dirt and microbubble separators and cyclonic vacuum degassers, so we can offer the best solution for every problem caused by air and dirt.



IMI Hydronic Engineering
Route de Crassier 19
CH-1262 Eysins
Switzerland

www.imi-hydronic.com

